

---

PRODUCT CATALOGUE

# **Harnessflex®**

Providing superior protection  
for automotive wiring harnesses



***Harnessflex***

---

**Harnessflex offers complete system solutions for the routing and protection of electrical wiring against damage by mechanical abrasion, liquid ingress and corrosion.**

**Using a Harnessflex conduit system ensures that cables and vulnerable connectors are not exposed to the elements, impact of foreign bodies or jet washing, all of which can cause vehicles and machines to malfunction and fail.**

---

# Table of contents

<b>004</b> –005	<b>Introduction</b>
<b>006</b> –007	<b>Company services</b>
<b>006</b> –017	<b>Harnessflex conduit systems</b>
<b>018</b> –029	<b>Conduit fittings and connector interfaces</b>
<b>030</b> –031	<b>CCSB Conduit clips</b>
<b>034</b> –034	<b>Fitting accessories</b>
<b>036</b> –053	<b>Connector interfaces</b>
<b>054</b> –068	<b>Sealed fittings</b>
<b>066</b> –067	<b>Sealed fitting accessories</b>
<b>068</b> –069	<b>General accessories</b>
<b>070</b> –078	<b>Technical</b>



# Introduction

## Company overview

Harnessflex was established in 1984 and is a leading designer and manufacturer of flexible conduit systems and connector interfaces, protecting critical electrical and electronic wiring assemblies in the automotive industry.

—  
01 **TPS T-piece** - External conduit fitting with Multi-way reducer.

### Applications

Harnessflex provides harness solutions for:

- Agricultural vehicles
- Construction vehicles
- Engine manufacturers
- Harness manufacturers
- Truck & bus manufacturers
- Tanker & trailer manufacturers
- Specialist vehicle components
- Military vehicles

Harnessflex offers complete system solutions for the routing and protection of electrical wiring against damage by mechanical abrasion, liquid ingress and corrosion salts. Using a Harnessflex conduit system ensures that vulnerable connectors are not exposed to the elements, impact of foreign bodies or jet washing, all of which can cause vehicle malfunction and failure.

Our success has come from our systematic commitment to providing an extensive range of high-grade quality components. Combining a full range of slit and un-slit conduit, fittings and connectors, we also offer a large range of hinged system components and connector interfaces.

### Our customers

Offering bespoke design that utilises our extensive range of interfaces, we can offer tailored and innovative solutions for a range of applications.

### Quality approvals and standards

Manufacturing is controlled in accordance with BS EN ISO 9001, whilst ongoing testing is conducted to the highest international standards and approvals. This provides the confidence that Harnessflex products can be used across the widest variety of automotive applications, including those in the harshest and most aggressive environments.

All components comply with End of Life Vehicle (ELV) directive EU2000/53/EC. Harnessflex also comply to ISO14001 - Environmental Standard.



# Company overview

## Our services

From bespoke design of innovative products to in-house performance testing to levels even above the highest global standards, at Harnessflex we ensure quality at every step.

At Harnessflex, we deliver specialist conduit systems suitable for use in a variety of applications, temperatures and environmental conditions. To achieve this, we work closely alongside OEMs and harness makers to deliver bespoke design systems that are built for purpose. In addition, all the products we manufacture are extensively tested in our in-house testing facility, ensuring they meet the highest levels of performance at all times.

### Conduit systems designed to specification

Following a specification from the OEM, our technical team will draw up detailed final system designs, with 3D printed samples and prototypes for approval. Once signed off, the product will be commissioned for manufacture, with our technical team continuing to deliver engineering and design support throughout the process.

### In-house product testing program

ABB has invested in a new testing facility at the Coleshill, UK site for its global cable protection portfolio. Our 1,150sqft facility offers a broad spectrum of testing capacity, from feasibility research to ingress protection, mechanical testing and the accelerated simulation of extreme working environments. The site infrastructure includes hi-end test equipment, most notably, an automated ingress protection water chamber capable of IP X5, X6, X9 testing in accordance with many globally recognised standards.

Our complete product testing capabilities include:

- **Ingress Protection (IP)** - Capable of testing to IPX3, IPX4, IPX5, IPX6, IPX7, IPX8 (to 20 Bar) and IPX9
- **Climatic** - Testing performance in temperatures from -70 to +180 degrees Celsius
- **Mechanical testing** - Including tensile, compression, impact and abrasion at extremes of temperature to establish long term product resilience, resistance and stability. Additionally testing to destruction to assess maximum performance levels.

Through our internal design and testing resources, we are able to deliver high-performance tailored solutions for a variety of challenging operating conditions, to the highest industry standards. By combining our R&D operations, product manufacturing and testing processes into one Harnessflex services package, we can deliver market-leading cable protection solutions to customers around the world, in an accurate and efficient manner.

As standard, we offer a 5 year extended warranty on all Harnessflex products that are installed as part of a complete, fully integrated system.





**5 year warranty on your Harnessflex system**

As all Harnessflex products are intensively tested under the most extreme conditions, we can guarantee the durability of the systems we provide. That's why as standard, we offer a 5 year extended warranty on all Harnessflex products that are installed as part of a complete, fully integrated Harnessflex system.

This gives you and your customers the peace of mind that once your Harnessflex system is installed, it will deliver lasting protection of critical wiring over the vehicle's lifespan.

---

# Harnessflex conduit systems

## Introduction

Harnessflex conduit systems are built for performance, designed to protect critical wiring in harnesses on HGVs, off-road vehicles and other heavy automotives.

—  
01 NC Standard weight  
polyamide 6 conduit.

Harnessflex has the largest range of flexible conduits, sealed fittings, hinged connector interfaces and Y&T pieces, anywhere in the global cable protection market. Constantly evolving through innovation driven by some of the most demanding automotive industry sectors, Harnessflex products are designed to be used together as a system for easy installation and complete wiring harness protection.

Featuring a unique vibration friendly profile (VFP) as standard, as well as UV and heat stabilisation as standard, Harnessflex conduit systems provide 10-150% greater life expectancy in dynamic or vibrating applications, when compared with other products. This maximises the productivity of the system being protected, whilst minimising the risk of electrical failure.

From fit-and-forget CPC conduit systems offering unbeatable dynamic performance, to our TempGuard range that is designed and tested to withstand extreme temperatures, Harnessflex can provide a solution for most applications and environments.

### Features & benefits:

- High flexibility and fatigue life - continuous performance over a long product lifespan
- Protects critical cables with very high abrasion, impact and shock resistance
- Specialist ranges for use in extreme high and low temperatures
- Range includes products with IP40-IP69 rating, as well as self-extinguishing and low fire hazard capabilities and fittings offering reduction options
- VFP as standard, delivering minimal cable abrasion
- Designed to maximise tensile strength and reduce together with all Harnessflex connector interface, Y&T and joining system installations
- 100% inspected and tested





# Product selection guide

## Conduit

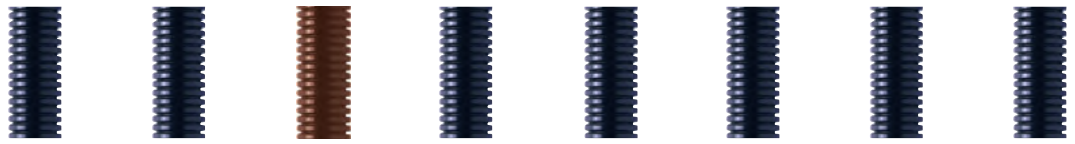

Product selection guide

Type	NC	CTPA	HTC	CPC	NCV	HNC	PP	DSPP
Conduit material	Polyamide 6	Polyamide 6	Modified Co-Polyester FR	Co-Polyester	FR Polyamide 6	Polyamide 12	Poly-propylene	Modified Poly-propylene
Conduit weight	Standard	Light	Medium	Medium	Standard	Standard	Medium	Medium
Slit version available	•	•	•	–	–	–	–	Slit only
Colour	●●●●	●●	●	●	●	●	●	●
<b>Temperature range</b>								
Long term static min.	-40°C	-40°C	-50°C	-50°C	-40°C	-60°C	-20°C	-20°C
Long term static max.	+120°C	+120°C	+150°C	+135°C	+120°C	+105°C	+90°C	+90°C
Short term (3000 hrs)	+150°C	+135°C	+175°C	+150°C	+150°C	+120°C	+105°C	+105°C
Short term (200 hrs)	+175°C	+150°C	+190°C	+175°C	+170°C	+135°C	+105°C	+120°C
<b>Characteristics</b>								
UV resistance	■■■■■	■■■■■	■■■■■	■■■■■	■■■■■	■■■■■	■■■■■	■■■■■
Flexibility	■■■■■	■■■■■	■■■■■	■■■■■	■■■■■	■■■■■	■■■■■	■■■■■
Fatigue life	■■■■■	■■■■■	■■■■■	■■■■■	■■■■■	■■■■■	■■■■■	■■■■■
Ext. wear resistance	■■■■■	■■■■■	■■■■■	■■■■■	■■■■■	■■■■■	■■■■■	■■■■■
Self extinguishing	•	•	•	•	•	•	–	•
Halogen free	•	•	•	•	•	•	•	•
Low smoke toxicity	•	•	•	•	•	•	–	–
<b>Approvals</b>								
CE	•	•	•	•	•	•	•	•
UL94 V0	–	–	–	–	•	–	–	–
UL94 V2	–	–	–	•	–	–	–	•
UL94 HB	•	•	•	–	–	•	•	–
R118	•	–	–	–	–	–	–	–
RoHS Compliant	•	•	•	•	•	•	•	•
ADR Approved	•	–	–	–	–	–	–	–
(ELV) EU200/53/EC	•	•	•	•	•	•	•	•
<b>Chemical resistance*</b>								
IRM 903 (ASTM Oil No.2)	S	S	S	S	S	S	S	S
Diesel Oil	S	S	S	S	S	S	S	S
Ethylene Glycol (Anti-freeze)	S	S	S	S	S	S	S	S
Lubricating Oil	S	S	S	S	S	S	S	S
Methyl Alcohol	L	L	S	S	L	S	S	S
Parafin Oil	S	S	S	S	S	S	S	S
Petrol	S	S	S	S	S	S	S	S
Sodium Chloride	S	S	S	S	S	S	S	S
Sodium Hydroxide (10%)	S	S	S	S	S	S	S	S
Transformer Oil	S	S	S	S	S	S	S	S
Urea	S	S	S	NT	S	S	NT	NT
Vegetable Oil	S	S	S	S	S	S	S	S
Sea (Water)	S	S	S	S	S	S	S	S

Key: S = Suitable / L = Limited Suitability / U = Unsustainable / NT = Not Tested / Maximum Performance = ■■■■■

\*All chemicals tested for resistance at 23°C.

Page No.	10	11	12	13	14	15	16	17
----------	----	----	----	----	----	----	----	----

## NC Standard weight, polyamide 6

### General purpose conduit



Solid



Slit

#### Description

Flexible standard weight nylon (PA6) conduit is a general-purpose conduit suitable for automotive harness applications. Able to withstand extremes of temperatures and resistant to automotive oils and solvents. It is extremely tough and has a very high impact strength and high fatigue life.

#### Applications

NC standard weight conduit is extensively used in harnesses on HGV and off road vehicle applications where a superior protection against impact and mechanical shock is preferred. The conduit is used for both chassis and engine applications and can be used in a wide range of temperatures. Polyamide 6 is highly resistant to all hydrocarbon based oils and fluids and many types of solvents.

#### NC Standard weight

Materials: Polyamide 6

Approvals	IP Rating	Appropriate fitting	Temperature range	UV resistance
ADR Approved (Sealed fittings)	IP40	Hinged fittings	Long term: -40°C to +120°C	Very high (Black)
UL94 HB rated		NC Slit (IP40 only)	Short term: +150°C	
CE Mark to the Low Voltage Directive	IP67	Sealed fittings	<b>Fire performance</b>	
RoHS Compliant to 2011/65/EU	IP68 (2 bar 30 mins)	Sealed fittings	Self extinguishing	Low smoke toxicity
Reg 118		<b>Degree of mechanical protection</b>		
Conforms with End of Life Vehicle directive (ELV) EU200/53/EC	High flexibility & fatigue life		Halogen free	
	Very high abrasion, impact and shock resistance			
	Suited to high risk impact applications			



#### Dimensions

	Solid Part No.	Slit Part No.	Conduit size		Nominal O/D	Min. bore	Min. static bend radius	Reel length (m)
			NC	NW	A (mm)	B (mm)	C (mm)	
	NC06	NC06-S	06	4.5	7.1	4.5	5.0	100
	NC08	NC08-S	08	7.5	10.0	6.5	15.0	100
	NC10	NC10-S	10	8.5	11.5	8.4	15.0	100
	NC12	NC12-S	12	10	13.0	9.9	20.0	100
	NC16	NC16-S	16	13	16.0	11.8	30.0	100
	NC20	NC20-S	20	17	21.2	16.6	35.0	50
	NC25	NC25-S	25	22	25.6	21.3	40.0	50
	NC28	NC28-S	28	23	28.5	22.6	45.0	50
	NC30	NC30-S	30	26	31.6	26.0	50.0	50
	NC32	NC32-S	32	29	34.5	28.8	55.0	50
	NC40	NC40-S	40	36	42.5	34.8	65.0	25
	NC50	NC50-S	50	48	54.5	46.9	70.0	25

Colours available: Black ● RAL 9001 / Orange ● RAL 2003 / Red ● RAL 3031 / \*Other colour options available, subject strictly to MOQ.

To order quote part number & reel length, e.g. NC06/100m. For slit conduit options add -S to part number, e.g. NC06-S/100m.

For colours other than standard Black also add colour, i.e. /OR for Orange conduit, e.g. NC06/OR/100m.

Bulk coil lengths over 200m are also available.

## CTPA Lightweight, polyamide 6

Extra flexible conduit

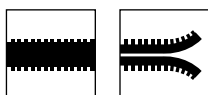

Solid

Slit

### Description

Extra flexible lightweight nylon (PA6) conduit is a general-purpose conduit suitable for electrical loom applications. Able to withstand extremes of temperatures and resistant to automotive oils and solvents. It is extremely tough and has a medium impact strength and high fatigue life.

### Applications

CTPA lightweight conduit is extensively used in general purpose, lightweight electrical loom applications. Polyamide 6 is highly resistant to all hydrocarbon based oils and fluids and many types of solvents.

### CTPA Lightweight

Materials: Polyamide 6

Approvals	IP Rating	Appropriate fitting	Temperature range	UV resistance
CE Mark to the Low Voltage Directive	IP40	Hinged fitting	Long term: -40°C to +120°C	Very high (Black)
UL94 HB rated	IP67	Sealed fittings	Short term: +150°C	
RoHS Compliant to 2011/65/EU	<b>Degree of mechanical protection</b>		<b>Fire performance</b>	
Conforms with End of Life Vehicle directive (ELV) EU200/53/EC	High flexibility & fatigue life		Self extinguishing	
	Medium impact resistance - suited to lower impact risk applications		Low smoke toxicity	
			Halogen free	



### Dimensions

	Solid Part No.	Slit Part No.	Conduit size		Nominal O/D A (mm)	Min. bore B (mm)	Min. static bend radius C (mm)	Reel length (m)
			NC	NW				
	CTPA08	CTPA08-S	08	7.5	10.0	6.5	10.0	100
	CTPA10	CTPA10-S	10	8.5	11.5	8.7	15.0	100
	CTPA12	CTPA12-S	12	10	13.0	10.1	20.0	100
	CTPA16	CTPA16-S	16	13	16.0	11.8	35.0	100
	CTPA20	CTPA20-S	20	17	21.2	16.9	45.0	50
	CTPA25	CTPA25-S	25	22	25.6	21.3	45.0	50
	CTPA28	CTPA28-S	28	23	28.5	23.1	45.0	50
	CTPA32	CTPA32-S	32	29	34.5	28.8	55.0	50
	CTPA40	CTPA40-S	40	36	42.5	35.0	65.0	25
	CTPA50	CTPA50-S	50	48	54.5	46.0	90.0	25

Colours available: Black ● RAL 9001 / Orange ● RAL 2003 / \*Other colour options available, subject strictly to MOQ.

To order quote part number & reel length, e.g. CTPA08/100m. For slit conduit options add -S to part number, e.g. CTPA08-S/100m.

For colours other than standard Black also add colour, i.e. /OR for Orange conduit, e.g. CTPA08/OR/100m.

Bulk coil lengths over 200m are also available.

## HTC High temperature, modified co-polyester

### High temperature conduit

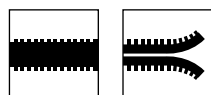

Solid

Slit

#### Description

Flexible high temperature, modified co-polyester conduit is a high temperature conduit suitable for automotive harness applications. Able to withstand extremes of temperatures and resistant to automotive oils and solvents. It is extremely tough and has a very high impact strength and fatigue life.

#### Applications

HTC high temperature, modified co-polyester conduit has been developed for use where elevated temperatures occur. Suitable for long term exposure, up to 190°C. HTC is resistant to hydrocarbons, greases, fuels and oils.

#### HTC Medium weight

Materials: Modified Co-Polyester

Approvals	IP Rating	Appropriate fitting	Temperature range	UV resistance
CE Mark to the Low Voltage Directive	<b>IP40</b>	TempGuard & standard hinged fittings	Long term: -50°C to +175°C	Very high
RoHS Compliant to 2011/65/EU	<b>IP67</b>	Sealed fittings	Short term: +190°C	
Conforms with End of Life Vehicle directive (ELV) EU200/53/EC	<b>Degree of mechanical protection</b>		<b>Fire performance</b>	
	Very high flexibility & fatigue life		Self extinguishing	
	Very high elevated temperature, abrasion, impact and shock resistance		Halogen free	



#### Dimensions

	Solid Part No.	Slit Part No.	Conduit size		Nominal O/D A (mm)	Min. bore B (mm)	Min. static bend radius C (mm)	Reel length (m)
			NC	NW				
	HTC06	HTC06-S	06	4.5	7.1	4.5	5.0	100
	HTC08	HTC08-S	08	7.5	9.8	6.2	20.0	50
	HTC10	HTC10-S	10	8.5	11.5	8.7	15.0	50
	HTC12	HTC12-S	12	10	13.0	9.4	25.0	50
	HTC16	HTC16-S	16	13	16.0	11.0	30.0	50
	HTC20	HTC20-S	20	17	21.2	16.1	40.0	50
	HTC25*	HTC25-S	25	22	25.3	21.0	45.0	50
	HTC28*	HTC28-S	28	23	28.5	22.5	45.0	50
	HTC32*	HTC32-S	32	29	34.5	27.2	55.0	50
	HTC40*	HTC40-S	40	36	42.5	34.8	65.0	25
	HTC50*	HTC50-S	50	48	54.5	46.9	70.0	25

Colours available: Brown ● RAL 8016. To order quote part number & reel length, e.g. HTC08/50m. For slit conduit options add -S to part number, e.g. NC08-S/50m.

## CPC Medium weight, FR co-polyester

### Flame retardant conduit



Solid

#### Description

Flexible medium weight, FR co-polyester conduit is a flame retardant, medium weight conduit suitable for automotive harness applications. Able to withstand extremes of temperatures and resistant to automotive oils and solvents. It is extremely tough and has a very high impact strength and fatigue life.

#### Applications

A low smoke, low toxicity conduit, CPC has excellent high and low temperature properties, making it ideal for harness applications such as engine, body section and chassis. CPC is resistant to hydrocarbons, greases, fuels and oils. Contact us for slit conduit options.

#### CPC Medium weight

Materials: FR Co-Polyester

Approvals	IP Rating	Appropriate fitting	Temperature range	UV resistance
CE Mark to the Low Voltage Directive	IP40	Hinged fitting	Long term: -50°C to +135°C	Very high
UL94 V2 rated	IP67	Sealed fittings	Short term: +175°C	
RoHS Compliant to 2011/65/EU	<b>Degree of mechanical protection</b>		<b>Fire performance</b>	
Conforms with End of Life Vehicle directive (ELV) EU200/53/EC	Very high flexibility & fatigue life		Self extinguishing	
	Very high abrasion, impact and shock resistance at low temperatures		Low smoke toxicity	
			Halogen free	



#### Dimensions

Solid Part No.	Conduit size		Nominal O/D	Min. bore	Min. static bend radius	Reel length (m)
	NC	NW	A (mm)	B (mm)	C (mm)	
CPC08	08	7.5	9.8	6.2	20.0	100
CPC12	12	10	13.0	9.4	25.0	100
CPC16	16	13	16.0	11.0	30.0	50
CPC20	20	17	21.2	16.1	40.0	50
CPC25	25	22	25.3	21.0	45.0	50
CPC28	28	23	28.5	22.5	45.0	50
CPC32	32	29	34.5	27.2	55.0	50
CPC40	40	36	42.5	34.2	60.0	25
CPC50	50	48	54.5	46.9	70.0	25

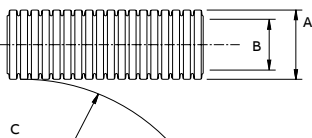

Colours available: Black ● RAL 9001. To order quote part number & reel length, e.g. CPC08/100m.

## NCV Standard weight, FR polyamide 6

Flame retardant conduit



Solid

### Description

Flexible standard weight, FR nylon (PA6) conduit is a flame retardant conduit suitable for automotive harness applications. Able to withstand average temperatures and resistant to automotive oils and solvents. It is extremely tough and has a very high impact strength and high fatigue life.

### Applications

NCV is used in applications requiring repeated flexing coupled with flame retardant resistance.

### NCV Standard weight

Materials: FR Polyamide 6

Approvals	IP Rating	Appropriate fitting	Temperature range	UV resistance
CE Mark to the Low Voltage Directive	<b>IP40</b>	Hinged fitting	Long term: -40°C to +120°C	Very high
UL94 V0 rated	<b>IP67</b>	Sealed fittings	Short term: +150°C	
RoHS Compliant to 2011/65/EU	<b>IP68</b> (2 bar 30 mins)	Sealed fittings	<b>Fire performance</b>	
Conforms with End of Life Vehicle directive (ELV) EU200/53/EC	<b>Degree of mechanical protection</b>		Self extinguishing	
	High flexibility & fatigue life		Low smoke toxicity	
	Very high abrasion, impact and shock resistance		Halogen free	
			UL94 V0 Rated	



### Dimensions

	Solid Part No.	Conduit size		Nominal O/D A (mm)	Min. bore B (mm)	Min. static bend radius C (mm)	Reel length (m)
		NC	NW				
	NCV06	06	4.5	7.2	4.5	10	100
	NCV08	08	7.5	9.8	6.2	20	100
	NCV10	10	8.5	11.5	8.0	23	100
	NCV12	12	10	13.0	9.6	26	100
	NCV16	16	13	16.0	11.7	32	100
	NCV20	20	17	21.2	16.3	42	50
	NCV25	25	22	25.3	21.3	52	50
	NCV28	28	23	28.5	22.5	57	50
	NCV32	32	29	34.5	28.6	79	50

Colours available: Black ● RAL 9001. To order quote part number & reel length, e.g. NCV06-S/100m.

## HNC Standard weight, polyamide 12

Low temperature, extra flexible conduit



Solid

### Description

Extra flexible standard weight nylon (PA12) conduit is suitable for low temperature automotive harness applications. It is extremely tough and has a very high impact strength and fatigue life.

### Applications

HNC is particularly used in applications requiring repeated flexing such as dynamic couplings, i.e. hydraulic arms and trailer couplings or rapid continuous motion, demanding high fatigue life and extra flexibility even in low temperature environments. Highly resistant to low temperature impact. HNC Standard weight conduit is designed for connection to all Harnessflex hinged and sealed fittings. Contact us for slit conduit options.

### HNC Standard Weight

Materials: Polyamide 12

Approvals	IP Rating	Appropriate fitting	Temperature range	UV resistance
CE Mark to the Low Voltage Directive	<b>IP40</b>	Hinged fitting	Long term: -60°C to +105°C	Very high
UL94 HB rated	<b>IP67</b>	Sealed fittings	Short term: +120°C	
RoHS Compliant to 2011/65/EU	<b>IP68 (2 bar 30 mins)</b>	Sealed fittings	<b>Fire performance</b>	
Conforms with End of Life Vehicle directive (ELV) EU200/53/EC	<b>Degree of mechanical protection</b>		Self extinguishing	
	Very high flexibility & fatigue life		Low smoke toxicity	
	Very high abrasion, impact and shock resistance at low temperatures		Halogen free	



### Dimensions

Solid Part No.	Conduit size		Nominal O/D A (mm)	Min. bore B (mm)	Min. static bend radius C (mm)	Reel length (m)
	NC	NW				
HNC08	08	7.5	10.0	6.2	15.0	100
HNC12	12	10	13.0	9.9	25.0	100
HNC16	16	13	15.8	11.7	30.0	100
HNC20	20	17	21.2	16.6	35.0	50
HNC25	25	22	25.3	21.0	40.0	50
HNC28	28	23	28.5	21.7	45.0	50
HNC32	32	29	34.5	27.7	55.0	50
HNC40	40	36	42.5	35.5	60.0	25
HNC50	50	48	54.5	46.6	70.0	25

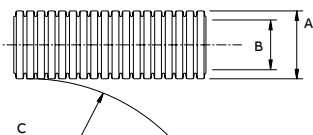

Colours available: Black ● RAL 9001. To order quote part number & reel length, e.g. HNC08/100m.

## PP Medium weight, polypropylene

### Polypropylene conduit



Solid

#### Description

Flexible medium weight, polypropylene conduit is suitable for automotive harness applications. Able to withstand average temperatures and resistant to automotive oils and solvents. It is extremely tough and has a high acid resistance and medium fatigue life.

#### Applications

PP is particularly used in lighter applications where compression strength and LFH is not so important. The main property of this conduit is acid resistance. PP is designed for connection to all Harnessflex Sealed and Hinged system fittings.

#### PP Medium weight

Materials: Polypropylene

Approvals	IP Rating	Appropriate fitting	Temperature range	UV resistance
CE Mark to the Low Voltage Directive	IP40	Hinged fitting	Long term: -20°C to +90°C	High
UL94 HB rated	IP67	Sealed fittings	Short term: +105°C	
RoHS Compliant to 2011/65/EU	<b>Degree of mechanical protection</b>		<b>Fire performance</b>	
Conforms with End of Life Vehicle directive (ELV) EU200/53/EC	High flexibility and acid resistance		Halogen free	
	Medium fatigue life, impact and shock resistance			



#### Dimensions

Solid Part No.	Conduit size		Nominal O/D A (mm)	Min. bore B (mm)	Min. static bend radius C (mm)	Reel length (m)
	NC	NW				
PP08	08	7.5	10.0	6.4	15.0	100
PP10	10	8.5	11.5	8.6	20.0	100
PP12	12	10	13.0	9.6	25.0	100
PP16	16	13	16.2	11.2	35.0	100
PP20	20	17	21.2	16.9	35.0	50
PP25	25	22	25.6	21.5	40.0	50
PP28	28	23	28.5	23.2	45.0	50
PP32	32	29	34.5	29.1	55.0	50

Colours available: Black ● RAL 9001. To order quote part number & reel length, e.g. PP08/100m. Bulk coil lengths over 200m are also available.



## DSPP Deep section, medium weight, modified polypropylene

Modified Polypropylene conduit



Slit

### Description

Flexible deep section, medium weight, modified polypropylene conduit is suitable for automotive harness applications. Able to withstand average temperatures and resistant to automotive oils and solvents. It is extremely tough and has a high acid resistance and medium fatigue life.

### Applications

DSPP has a deep section to maintain the conduit shape during bending. Deep Section Conduits are supplied in slit form to facilitate rapid cable installation and are designed for connection to all Harnessflex hinged fittings.

### DSPP Deep section medium weight

Materials: Modified Polypropylene

Approvals	IP Rating	Appropriate fitting	Temperature range	UV resistance
CE Mark to the Low Voltage Directive	IP40	Hinged fitting	Long term: -20°C to +90°C	Very high
UL94 V2 rated	<b>Degree of mechanical protection</b>		Short term: +105°C	
RoHS Compliant to 2011/65/EU	High flexibility and acid resistance		<b>Fire performance</b>	
Conforms with End of Life Vehicle directive (ELV) EU200/53/EC	Medium fatigue life, impact and shock resistance		Halogen free	



### Dimensions

Slit Part No.	Conduit size		Nominal O/D A (mm)	Min. bore B (mm)	Min. static bend radius C (mm)	Reel length (m)
	NC	NW				
DSPP12-S	12	10	13.0	8.5	18.0	100
DSPP16-S	16	13	16.2	11.1	32.0	100
DSPP20-S	20	17	21.2	15.0	40.0	50
DSPP28-S	28	23	28.5	21.7	50.0	50
DSPP32-S	32	29	34.5	27.7	58.0	50
DSPP40-S	40	36	42.5	34.6	80.0	25

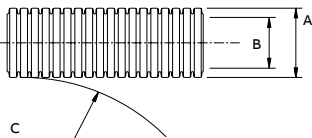

Colours available: Black ● RAL 9001. To order quote part number & reel length, e.g. DSPP12-S/100m.

# Conduit fittings and connector interfaces

## Introduction

Harnessflex conduit fittings and connector interfaces are designed to offer effective stable joints and connections in a wiring harness, that also shield against high pressure wash-down, excessive dust ingress, cable strain and mechanical abrasion.

### Capabilities

Harnessflex works closely with many OEMs to develop protection for critical electrical wiring through two-piece or hinged joints and junctions, sealed fittings and bespoke connector interfaces.

Our experienced internal design team uses 3D CAD modelling software to constantly develop innovative new solutions, as well as various bespoke concepts for customer approval.

Through our astute understanding of customer requirements, Harnessflex products are designed and manufactured to integrate seamlessly into harnesses for various heavy automotive applications.

### Features & benefits

- Internal form of fittings protects cables from abrasion
- Internal backstop alleviates any potential problems caused by unevenly cut conduit and ensures correct assembly
- Interfaces can be used in areas where electrical connectors are vulnerable to high pressure washing
- Interfaces offer strain relief to crimped contacts
- When 90° swivel elbows are used with interfaces they allow the harness to self-level
- All Harnessflex Y, T and joiners can be used with CCSB to further enhance the conduit and connection's tensile and bending performance

### TempGuard

Modern engine design has continually evolved to meet changing times. Global regulations such as Euro 6, USA10, and Tier 4 for off-highway heavy duty vehicles have mandated that manufacturers reduce emission levels. This required reduction, along with EGR systems that recycle an engine's waste gases and the use of single or multiple turbos to improve tractability, power and fuel efficiency, have all contributed to higher engine running temperatures.

This has led to the automotive industry actively looking for a complete and effective solution for protecting wiring and connectors in their engines.

Harnessflex TempGuard conduits and fittings are a unique innovation designed to work specifically with high temperature wiring, allowing them to successfully operate at up to 200°C. Created from the outset for use as a full system, the range is made from specialist co-polyester and polyamide respectively, offering reliable protection for vital cable connections. The TempGuard system is manufactured from low smoke/zero halogen materials, and has also endured intensive long-term heat aging, tensile and impact strength testing to help ensure consistent performance.

### Features & benefits

- High temperature range (up to 200°C) consisting of HTC conduit, T and Y-Piece fittings, straight and elbow joiners and common connector interfaces
- Safely protects against heat, abrasion, vibration and automotive fluids in all harness routing areas
- Very high fatigue life
- Made from high temperature Polyamide material
- UL94 V2 rated material
- Intensively tested for high tensile and impact strength

### Key features:

- 1 **Compact design** - Reducing distance between centres
- 2 **High pull-off strength** - Conduit corrugations sit tightly into joiner junctions
- 3 **Integral retaining clips** - Retains conduit in position during assembly



01

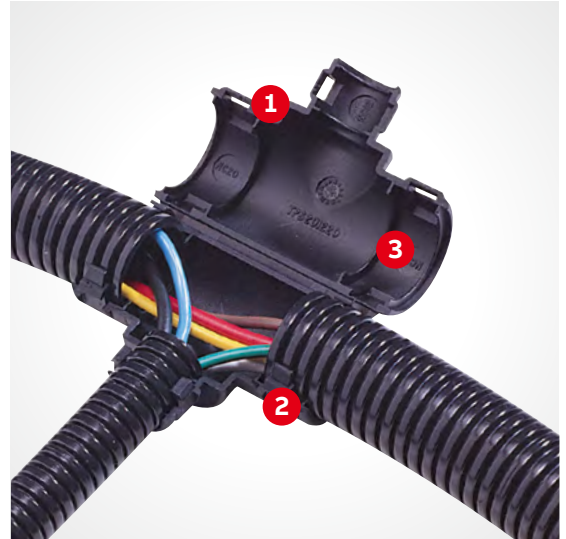

02



03

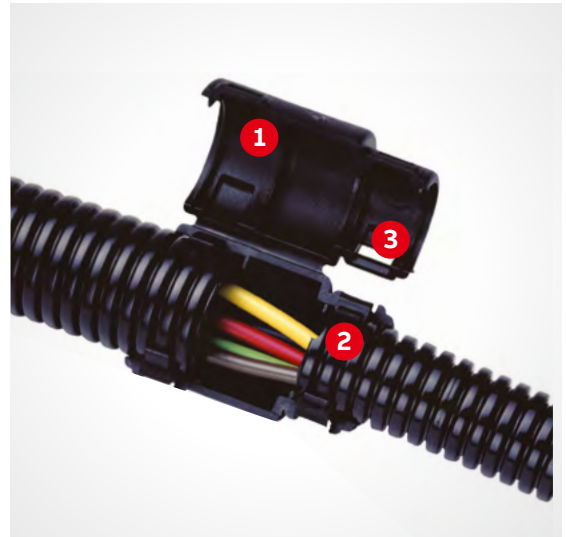

04

- 01 YPS Y-piece - External conduit fitting.
- 02 TPS T-piece - External conduit fitting.
- 03 EPS Elbow - External conduit fitting.
- 04 JPS Joiner - External conduit fitting.

**Standard fittings**

Approvals	IP Rating	Appropriate fitting	Temperature range	UV resistance
CE Mark to the Low Voltage Directive	IP40	All Harnessflex conduits	-40°C to +120°C	Very high
RoHS Compliant to 2011/65/EU		Yes	<b>Fire performance</b>	
Conforms with End of Life Vehicle directive (ELV) EU200/53/EC			Self extinguishing	
			Low smoke toxicity	
			Halogen free	



**TempGuard fittings**

Approvals	IP Rating	Appropriate fitting	Temperature range	UV resistance
CE Mark to the Low Voltage Directive	IP40	For use with: All conduits in the Harnessflex range	-40°C to +200°C	High
RoHS Compliant to 2011/65/EU		Yes	<b>Fire performance</b>	
Conforms with End of Life Vehicle directive (ELV) EU200/53/EC			Self extinguishing	
			Low smoke toxicity	
			Halogen free	
			UL94 V2 / UL94 RTI 150 (Elec)	



## JPS Joiner

### External conduit fitting



#### External joiner

One-piece joiner fittings allow a variety of conduit size variations. These fittings are designed to snap together over all types of slit and unslit conduit, maintaining maximum conduit bore. Can be used as an in-line reducer as well as an enlarger.

#### JPS / JPH External joiner

Part No.	TempGuard Part No.	Conduit size (NC)		Conduit size (NW)		Nominal dimensions (mm)			
		A	B	A	B	C	D	E	F
JPS1208	JPH1208	12	08	10	7.5	38.0	16.0	10.0	10.0
JPS1212	JPH1212	12	12	10	10	36.0	16.0	10.0	10.0
JPS1612	JPH1612	16	12	13	10	36.0	21.0	10.0	10.0
JPS1616	JPH1616	16	16	13	13	36.0	21.0	10.0	10.0
JPS2008	JPH2008	20	08	17	7.5	38.0	26.0	12.0	10.0
JPS2012	JPH2012	20	12	17	10	38.0	26.0	12.0	10.0
JPS2016	JPH2016	20	16	17	13	38.0	26.0	12.0	10.0
JPS2020	JPH2020	20	20	17	17	38.0	26.0	12.0	12.0
JPS2520	JPH2520	25	20	22	17	39.0	33.0	12.0	12.0
JPS2525	JPH2525	25	25	22	22	39.0	33.0	13.0	13.0
JPS2820	JPH2820	28	20	23	17	39.0	33.0	13.0	13.0
JPS2825	JPH2825	28	25	23	22	39.0	33.0	13.0	13.0
JPS2828	JPH2828	28	28	23	23	39.0	33.0	13.0	13.0

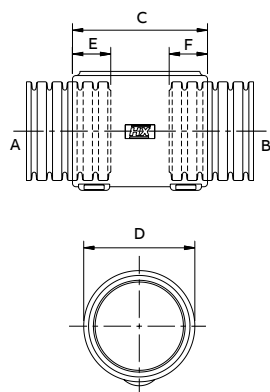

## EPS Elbow

### External conduit fitting



#### External hinged elbow

One-piece elbow fittings allow a variety of conduit size variations. These fittings are designed to snap together over all types of slit and unslit conduit, maintaining maximum conduit bore. Can be used as an in-line reducer as well as an enlarger.

#### EPS / EPH External elbow

	Part No.	TempGuard Part No.	Conduit size (NC)		Conduit size (NW)		Nominal dimensions (mm)				
			A	B	A	B	C	D	E	F	G
	EPS08S08*	EPH08S08	08	08	7.5	7.5	38.0	29.0	20.0	10.0	10.0
	EPS12S12*	EPH12S12	12	12	10	10	38.0	29.0	20.0	10.0	10.0
	EPS1608	EPH1608	16	08	10	7.5	34.0	34.0	21.0	10.0	10.0
	EPS1612	EPH1612	16	12	13	10	34.0	34.0	21.0	10.0	10.0
	EPS1616	EPH1616	16	16	13	13	34.0	34.0	21.0	10.0	10.0
	EPS2008	EPH2008	20	08	17	7.5	41.0	39.0	26.0	12.0	10.0
	EPS2012	EPH2012	20	12	17	10	41.0	41.0	26.0	10.0	10.0
	EPS2016	EPH2016	20	16	17	13	41.0	41.0	26.0	12.0	10.0
	EPS2020	EPH2020	20	20	17	17	41.0	41.0	26.0	12.0	12.0
	EPS2520	EPH2520	25	20	22	17	48.0	48.0	33.0	13.0	12.0
	EPS2525	EPH2525	25	25	22	22	48.0	48.0	33.0	13.0	13.0
	EPS2812	EPH2812	28	12	23	10	48.0	48.0	33.0	13.0	10.0
	EPS2816	EPH2816	28	16	23	13	48.0	48.0	33.0	13.0	10.0
	EPS2820	EPH2820	28	20	23	17	48.0	48.0	33.0	13.0	12.0
	EPS2825	EPH2825	28	25	23	22	48.0	48.0	33.0	13.0	13.0
	EPS2828	EPH2828	28	28	23	23	48.0	48.0	33.0	13.0	13.0
EPS3232	EPH3232	32	32	29	29	60.0	60.0	38.0	12.0	12.0	
EPS4040	EPH4040	40	40	36	36	67.0	67.0	47.0	15.0	15.0	

\*Swivel fitting.

## YPS Y-piece

### External conduit fitting



#### External Y-piece

Asymmetrical 3 junction fittings allow a variety of conduit size variations. These fittings are designed to snap together over all types of slit and unslit conduit, maintaining maximum conduit bore.

YPS / YPH External Y-piece

Part No.	TempGuard Part No.	Conduit size (NC)			Conduit size (NW)			Nominal dimensions (mm)				
		A	B	C	A	B	C	D	E	F	G	H
YPS060606*	YPH060606*	06	06	06	4.5	4.5	4.5	55.0	37.0	10.0	10.0	10.0
YPS080808	YPH080808	08	08	08	7.5	7.5	7.5	55.0	37.0	10.0	10.0	10.0
YPS080812	YPH080812	08	08	12	7.5	7.5	10	55.0	37.0	10.0	10.0	10.0
YPS081208	YPH081208	08	12	08	7.5	10	7.5	55.0	37.0	10.0	10.0	10.0
YPS101010	YPH101010	10	10	10	8.5	8.5	8.5	55.0	37.0	10.0	10.0	10.0
YPS120808	YPH120808	12	08	08	10	7.5	7.5	55.0	37.0	10.0	10.0	10.0
YPS120810	YPH120810	12	08	10	10	7.5	8.5	55.0	37.0	10.0	10.0	10.0
YPS120812	YPH120812	12	08	12	10	7.5	10	55.0	37.0	10.0	10.0	10.0
YPS121010	YPH121010	12	10	10	10	8.5	8.5	55.0	37.0	10.0	10.0	10.0
YPS121208	YPH121208	12	12	08	10	10	7.5	55.0	37.0	10.0	10.0	10.0
YPS121210	YPH121210	12	12	10	10	10	8.5	55.0	37.0	10.0	10.0	10.0
YPS121212	YPH121212	12	12	12	10	10	10	55.0	37.0	10.0	10.0	10.0
YPS160812	YPH160812	16	08	12	13	7.5	10	55.0	37.0	10.0	10.0	10.0
YPS161010	YPH161010	16	10	10	13	8.5	8.5	55.0	40.0	10.0	10.0	10.0
YPS161208	YPH161208	16	12	08	13	10	7.5	55.0	40.0	10.0	10.0	10.0
YPS161210	YPH161210	16	12	10	13	10	8.5	55.0	40.0	10.0	10.0	10.0
YPS161212	YPH161212	16	12	12	13	10	10	55.0	40.0	10.0	10.0	10.0
YPS161608	YPH161608	16	16	08	13	13	7.5	55.0	40.0	10.0	10.0	10.0
YPS161610	YPH161610	16	16	10	13	13	8.5	55.0	40.0	10.0	10.0	10.0
YPS161612	YPH161612	16	16	12	13	13	10	55.0	40.0	10.0	10.0	10.0
YPS200808	YPH200808	20	08	08	17	7.5	7.5	43.0	37.0	12.0	10.0	10.0
YPS201208	YPH201208	20	12	08	17	10	7.5	43.0	37.0	12.0	10.0	10.0
YPS201210	YPH201210	20	12	10	17	10	8.5	43.0	37.0	12.0	10.0	10.0
YPS201212	YPH201212	20	12	12	17	10	10	43.0	37.0	12.0	10.0	10.0
YPS201608	YPH201608	20	16	08	17	13	7.5	43.0	37.0	12.0	10.0	10.0
YPS201612	YPH201612	20	16	12	17	13	10	48.0	40.0	12.0	10.0	10.0
YPS201616	YPH201616	20	16	16	17	13	13	48.0	40.0	12.0	10.0	10.0
YPS202008	YPH202008	20	20	08	17	17	7.5	56.0	45.0	12.0	10.0	10.0
YPS202010	YPH202010	20	20	10	17	17	8.5	58.0	45.0	12.0	12.0	10.0
YPS202012	YPH202012	20	20	12	17	17	10	58.0	45.0	12.0	12.0	10.0
YPS202016	YPH202016	20	20	16	17	17	13	64.0	48.0	12.0	12.0	10.0
YPS252020	YPH252020	25	20	20	22	17	17	54.0	49.0	10.0	12.0	12.0
YPS252508	YPH252508	25	25	08	22	22	7.5	67.0	56.0	10.0	12.0	10.0
YPS252510	YPH252510	25	25	10	22	22	8.5	67.0	56.0	10.0	13.0	10.0
YPS252512	YPH252512	25	25	12	22	22	10	67.0	56.0	10.0	13.0	10.0
YPS252516	YPH252516	25	25	16	22	22	13	67.0	56.0	10.0	13.0	10.0
YPS252520	YPH252520	25	25	20	22	22	17	77.0	60.0	10.0	13.0	12.0

\*Item supplied as kit with x3 insertable reducer.

# YPS Y-piece

External conduit fitting (continued)

Part No.	TempGuard Part No.	Conduit size (NC)			Conduit size (NW)			Nominal Dimensions (mm)				
		A	B	C	A	B	C	D	E	F	G	H
YPS252525	YPH252525	25	25	25	22	22	22	91.0	67.0	10.0	13.0	13.0
YPS282012	YPH282012	28	20	12	23	17	10	54.0	49.0	10.0	13.0	10.0
YPS282016	YPH282016	28	20	16	23	17	13	54.0	49.0	10.0	12.0	10.0
YPS282020	YPH282020	28	20	20	23	17	17	54.0	49.0	10.0	12.0	12.0
YPS282512	YPH282512	28	25	12	23	22	10	67.0	56.0	10.0	12.0	10.0
YPS282520	YPH282520	28	25	20	23	22	17	77.0	60.0	10.0	13.0	12.0
YPS282525	YPH282525	28	25	25	23	22	22	91.0	67.0	10.0	13.0	13.0
YPS282808	YPH282808	28	28	08	23	23	7.5	67.0	56.0	10.0	13.0	10.0
YPS282812	YPH282812	28	28	12	23	23	10	67.0	56.0	10.0	13.0	10.0
YPS282816	YPH282816	28	28	16	23	23	13	67.0	56.0	10.0	13.0	10.0
YPS282820	YPH282820	28	28	20	23	23	17	77.0	60.0	10.0	13.0	12.0
YPS282825	YPH282825	28	28	25	23	23	22	91.0	67.0	12.0	13.0	13.0
YPS282828	YPH282828	28	28	28	23	23	23	91.0	67.0	12.0	13.0	13.0
YPS322516	YPH322516	32	25	16	29	22	13	100.0	75.0	12.0	13.0	10.0
YPS322520	YPH322520	32	25	20	29	22	17	100.0	76.0	12.0	13.0	12.0
YPS322525	YPH322525	32	25	25	29	22	22	100.0	79.0	12.0	13.0	13.0
YPS322532	YPH322532	32	25	32	29	22	29	100.0	82.0	12.0	13.0	13.0
YPS323216	YPH323216	32	32	16	29	29	13	100.0	75.0	12.0	13.0	10.0
YPS323220	YPH323220	32	32	20	29	29	17	100.0	76.0	12.0	13.0	12.0
YPS323225	YPH323225	32	32	25	29	29	22	100.0	79.0	12.0	13.0	13.0
YPS323232	YPH323232	32	32	32	29	29	29	100.0	82.0	13.0	13.0	13.0
YPS403212	YPH403212	40	32	12	36	29	10	133.0	91.0	15.0	12.0	10.0
YPS403216	YPH403216	40	32	16	36	29	13	133.0	92.0	15.0	12.0	10.0
YPS403225	YPH403225	40	32	25	36	29	22	133.0	92.0	15.0	12.0	12.0
YPS403228	YPH403228	40	32	28	36	29	23	133.0	92.0	15.0	12.0	12.0
YPS404012	YPH404012	40	40	12	36	36	10	135.0	93.0	15.0	15.0	10.0
YPS404016	YPH404016	40	40	16	36	36	13	135.0	9.03	15.0	15.0	10.0
YPS404025	YPH404025	40	40	25	36	36	22	135.0	93.0	15.0	15.0	12.0
YPS404028	YPH404028	40	40	28	36	36	23	135.0	93.0	15.0	15.0	12.0
YPS404032	YPH404032	40	40	32	36	36	29	135.0	96.0	15.0	15.0	12.0
YPS404040	YPH404040	40	40	40	36	36	36	135.0	100.0	15.0	15.0	15.0

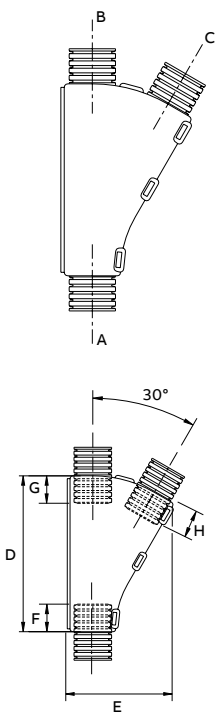

## TPS T-piece

### External conduit fitting



#### External T-piece

3 junction fittings allow a variety of conduit size variations. These fittings are designed to snap together over all types of slit and unslit conduit, maintaining maximum conduit bore.

TPS / TPH External T-piece

Part No.	TempGuard Part No.	Conduit size (NC)			Conduit size (NW)			Nominal dimensions (mm)					
		A	B	C	A	B	C	D	E	F	G	H	I
TPS060606*	TPH060606*	06	06	06	4.5	4.5	4.5	45.2	31.1	17.0	10.0	10.0	10.0
TPS080808	TPH080808	08	08	08	7.5	7.5	7.5	45.2	31.1	17.0	10.0	10.0	10.0
TPS081208	TPH081208	08	12	08	7.5	10	7.5	45.2	31.1	17.0	10.0	10.0	10.0
TPS081612	TPH081612	08	16	12	7.5	13	10	45.2	31.1	17.0	10.0	10.0	10.0
TPS100808	TPH100808	10	08	08	8.5	7.5	7.5	45.2	31.1	17.0	10.0	10.0	10.0
TPS100810	TPH100810	10	08	10	8.5	7.5	8.5	45.2	31.1	17.0	10.0	10.0	10.0
TPS101010	TPH101010	10	10	10	8.5	8.5	8.5	45.2	31.1	17.0	10.0	10.0	10.0
TPS101012	TPH101012	10	10	12	8.5	8.5	13	45.2	31.1	17.0	10.0	10.0	10.0
TPS120808	TPH120808	12	08	08	10	7.5	7.5	45.2	31.1	17.0	10.0	10.0	10.0
TPS120812	TPH120812	12	08	12	10	7.5	10	45.2	31.1	17.0	10.0	10.0	10.0
TPS121010	TPH121210	12	10	10	10	8.5	8.5	45.2	31.1	17.0	10.0	10.0	10.0
TPS121012	TPH121012	12	10	12	10	8.5	10	45.2	31.1	17.0	10.0	10.0	10.0
TPS121208	TPH121208	12	12	08	10	10	7.5	45.2	31.1	17.0	10.0	10.0	10.0
TPS121210	TPH121210	12	12	10	10	10	7.5	45.2	31.1	17.0	10.0	10.0	10.0
TPS121212	TPH121212	12	12	12	10	10	10	45.2	31.1	17.0	10.0	10.0	10.0
TPS121612	TPH121612	12	16	12	10	13	10	45.2	31.1	21.0	10.0	10.0	10.0
TPS160808	TPH160808	16	08	08	13	7.5	7.5	49.1	34.8	21.0	10.0	10.0	10.0
TPS160812	TPH160812	16	08	12	13	7.5	10	49.1	34.8	21.0	10.0	10.0	10.0
TPS160816	TPH160816	16	08	16	13	7.5	13	49.1	34.8	21.0	10.0	10.0	10.0
TPS161012	TPH161012	16	10	12	13	8.5	10	49.1	34.8	21.0	10.0	10.0	10.0
TPS161016	TPH161016	16	10	16	13	8.5	13	49.1	34.8	21.0	10.0	10.0	10.0
TPS161212	TPH161212	16	12	12	13	10	10	49.1	34.8	21.0	10.0	10.0	10.0
TPS161216	TPH161216	16	12	16	13	10	13	49.1	34.8	21.0	10.0	10.0	10.0
TPS161608	TPH161608	16	16	08	13	13	7.5	49.1	34.8	21.0	10.0	10.0	10.0
TPS161612	TPH161612	16	16	12	13	13	10	49.1	34.8	21.0	10.0	10.0	10.0
TPS161616	TPH161616	16	16	16	13	13	13	49.1	34.8	21.0	10.0	10.0	10.0
TPS162012	TPH162012	16	20	12	13	17	10	49.1	34.8	21.0	10.0	10.0	10.0
TPS162016	TPH162016	16	20	16	13	17	13	49.1	34.8	21.0	10.0	10.0	10.0
TPS200816	TPH200816	20	08	16	17	7.5	13	56.5	41.0	26.0	12.0	10.0	10.0
TPS200820	TPH200820	20	08	20	17	7.5	17	56.5	41.0	26.0	12.0	10.0	12.0
TPS201016	TPH201016	20	10	16	17	8.5	13	56.5	41.0	26.0	12.0	10.0	10.0
TPS201020	TPH201020	20	10	20	17	8.5	17	56.5	41.0	26.0	12.0	10.0	12.0
TPS201216	TPH201216	20	12	16	17	10	13	56.5	41.0	26.0	12.0	10.0	10.0
TPS201220	TPH201220	20	12	20	17	10	17	56.5	41.0	26.0	12.0	10.0	12.0
TPS201612	TPH201612	20	16	12	17	13	10	56.5	41.0	26.0	12.0	10.0	10.0
TPS201616	TPH201616	20	16	16	17	13	13	56.5	41.0	26.0	12.0	10.0	10.0
TPS201620	TPH201620	20	16	20	17	13	17	56.5	41.0	26.0	12.0	10.0	12.0

\*Item supplied as kit with x3 insertable reducer.



# TPS T-piece

External conduit fitting (continued)

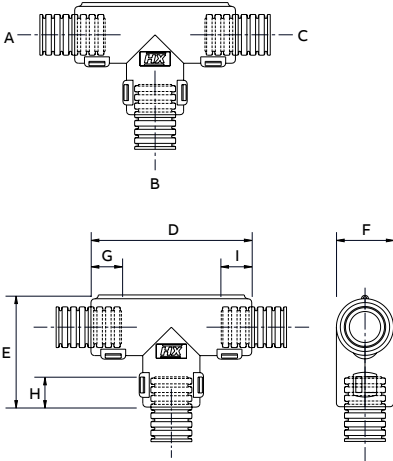

Part No.	TempGuard Part No.	Conduit size (NC)			Conduit size (NW)			Nominal dimensions (mm)					
		A	B	C	A	B	C	D	E	F	G	H	I
TPS202012	TPH202012	20	20	12	17	17	10	56.5	41.0	26.0	12.0	12.0	10.0
TPS202016	TPH202016	20	20	16	17	17	13	56.5	41.0	26.0	12.0	12.0	10.0
TPS202020	TPH202020	20	20	20	17	17	17	56.5	41.0	26.0	12.0	12.0	12.0
TPS202516	TPH202516	20	25	16	17	22	13	64.5	48.5	33.0	12.0	13.0	10.0
TPS250820	TPH250820	25	08	20	22	7.5	17	64.5	48.5	33.0	13.0	10.0	12.0
TPS250825	TPH250825	25	08	25	22	7.5	22	64.5	48.5	33.0	13.0	10.0	13.0
TPS251025	TPH251025	25	10	25	22	8.5	22	64.5	48.5	33.0	13.0	10.0	13.0
TPS251220	TPH251220	25	12	20	22	10	17	64.5	48.5	33.0	13.0	10.0	12.0
TPS251225	TPH251225	25	12	25	22	10	22	64.5	48.5	33.0	13.0	10.0	13.0
TPS251620	TPH251620	25	16	20	22	13	17	64.5	48.5	33.0	13.0	12.0	12.0
TPS251625	TPH251625	25	16	25	22	13	22	64.5	48.5	33.0	13.0	12.0	13.0
TPS252020	TPH252020	25	20	20	22	17	17	64.5	48.5	33.0	13.0	13.0	12.0
TPS252025	TPH252025	25	20	25	22	17	22	64.5	48.5	33.0	13.0	13.0	13.0
TPS252520	TPH252520	25	25	20	22	22	17	64.5	48.5	33.0	13.0	10.0	12.0
TPS252525	TPH252525	25	25	25	22	22	22	64.5	48.5	33.0	13.0	10.0	13.0
TPS280820	TPH280820	28	08	20	23	7.5	17	64.5	48.5	33.0	13.0	10.0	12.0
TPS280828	TPH280828	28	08	28	23	7.5	23	64.5	48.5	33.0	13.0	10.0	13.0
TPS281020	TPH281020	28	10	20	23	8.5	17	64.5	48.5	33.0	13.0	10.0	12.0
TPS281028	TPH281028	28	10	28	23	8.5	23	64.5	48.5	33.0	13.0	10.0	13.0
TPS281220	TPH281220	28	12	20	23	10	17	64.5	48.5	33.0	13.0	10.0	13.0
TPS281225	TPH281225	28	12	25	23	10	22	64.5	48.5	33.0	13.0	10.0	12.0
TPS281228	TPH281228	28	12	28	23	10	23	64.5	48.5	33.0	13.0	10.0	13.0
TPS281620	TPH281620	28	16	20	23	13	17	64.5	48.5	33.0	13.0	10.0	12.0
TPS281625	TPH281625	28	16	25	23	13	22	64.5	48.5	33.0	13.0	10.0	13.0
TPS281628	TPH281628	28	16	28	23	13	23	64.5	48.5	33.0	13.0	10.0	13.0
TPS282020	TPH282020	28	20	20	23	17	17	64.5	48.5	33.0	13.0	12.0	12.0
TPS282025	TPH282025	28	20	25	23	17	22	64.5	48.5	33.0	13.0	12.0	13.0
TPS282028	TPH282028	28	20	28	23	17	23	64.5	48.5	33.0	13.0	12.0	13.0
TPS282525	TPH282525	28	25	25	23	22	22	64.5	48.5	33.0	13.0	13.0	13.0
TPS282528	TPH282528	28	25	28	23	22	23	64.5	48.5	33.0	13.0	13.0	13.0
TPS282828	TPH282828	28	28	28	23	23	23	64.5	48.5	33.0	13.0	13.0	13.0

## TPS T-piece

External conduit fitting (continued)

Part No.	TempGuard Part No.	Conduit size (NC)			Conduit size (NW)			Nominal dimensions (mm)					
		A	B	C	A	B	C	D	E	F	G	H	I
TPS300830	TPH300830	30	08	30	26	7.5	26	72.0	55.3	39.0	12.0	10.0	12.0
TPS301230	TPH301230	30	12	30	26	10	26	72.0	55.3	39.0	12.0	10.0	12.0
TPS301625	TPH301625	30	16	25	26	13	22	72.0	55.3	39.0	12.0	10.0	12.0
TPS301630	TPH301630	30	16	30	26	13	26	72.0	55.3	39.0	12.0	10.0	12.0
TPS302020	TPH302020	30	20	20	26	17	17	72.0	55.3	39.0	12.0	12.0	12.0
TPS302025	TPH302025	30	20	25	26	17	22	72.0	55.3	39.0	12.0	12.0	12.0
TPS302030	TPH302030	30	20	30	26	17	26	72.0	55.3	39.0	12.0	12.0	12.0
TPS302525	TPH302525	30	25	25	26	22	22	72.0	55.3	39.0	12.0	12.0	12.0
TPS303025	TPH303025	30	30	25	26	26	22	72.0	55.3	39.0	12.0	12.0	12.0
TPS303030	TPH303030	30	30	30	26	26	26	72.0	55.3	39.0	12.0	12.0	12.0
TPS321625	TPH321625	32	16	25	29	13	22	72.0	55.3	39.0	13.0	10.0	13.0
TPS321632	TPH321632	32	16	32	29	13	29	72.0	55.3	39.0	13.0	10.0	13.0
TPS322532	TPH322532	32	25	32	29	22	29	72.0	55.3	39.0	13.0	10.0	13.0
TPS322025	TPH322025	32	20	25	29	17	22	72.0	55.3	39.0	13.0	12.0	13.0
TPS322028	TPH322028	32	20	28	29	17	23	72.0	55.3	39.0	13.0	12.0	13.0
TPS322032	TPH322032	32	20	32	29	17	29	72.0	55.3	39.0	13.0	12.0	13.0
TPS322525	TPH322525	32	25	25	29	22	22	72.0	55.3	39.0	13.0	13.0	13.0
TPS322532	TPH322532	32	25	32	29	22	29	72.0	55.3	39.0	13.0	13.0	13.0
TPS323225	TPH323225	32	32	25	29	29	22	72.0	55.3	39.0	13.0	13.0	13.0
TPS323232	TPH323232	32	32	32	29	29	29	72.0	55.3	39.0	13.0	13.0	13.0
TPS401232	TPH401232	40	12	32	36	10	29	85.0	65.0	47.0	15.0	10.0	12.0
TPS401240	TPH401240	40	12	40	36	10	36	87.0	65.0	47.0	15.0	10.0	15.0
TPS401632	TPH401632	40	16	32	36	13	29	85.0	65.0	47.0	15.0	10.0	12.0
TPS401640	TPH401640	40	16	40	36	13	36	87.0	65.0	47.0	15.0	10.0	15.0
TPS402040	TPH402040	40	20	40	36	17	36	87.0	65.0	47.0	15.0	12.0	15.0
TPS402540	TPH402540	40	25	40	36	22	36	87.0	65.0	47.0	15.0	12.0	15.0
TPS402840	TPH402840	40	28	40	36	23	36	87.0	65.0	47.0	15.0	12.0	15.0
TPS404016	TPH404016	40	40	16	36	36	13	85.0	70.0	47.0	15.0	15.0	12.0
TPS404032	TPH404032	40	40	32	36	36	29	85.0	70.0	47.0	15.0	15.0	12.0
TPS404040	TPH404040	40	40	40	36	36	36	87.0	70.0	47.0	15.0	15.0	15.0

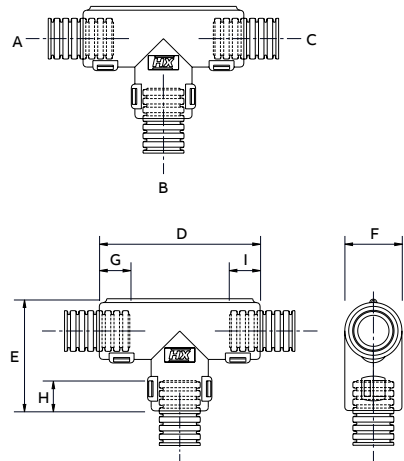

# XPS X-piece

External conduit fitting



### X configuration fitting

X configuration fitting designed to snap together to create closely packed conduit breakouts, allowing conduit to self level as the fitting rotates.

XPS External X-piece

Part No.	TempGuard Part No.	Conduit size (NC)				Conduit size (NW)				Conduit engagement (mm)				Nominal dimensions (mm)		
		A	B	C	D	A	B	C	D	E	F	G	H	I	J	K
XPS1208	XPH1208	12	08	12	08	10	7.5	10	7.5	9.5	7.0	9.5	7.0	42.3	5.5	38.0

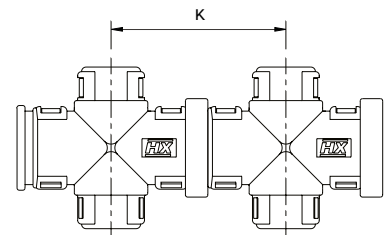
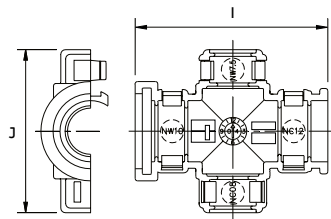
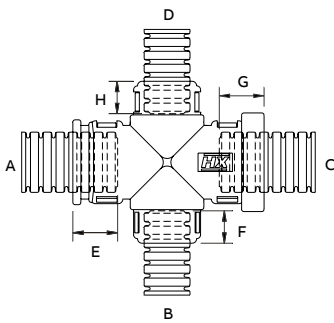

## CPS Protective shroud

Inline splicing, fuse and connector cover



### External protective shroud

Inline cover providing protection for connectors, fuse links, circuit breakers and splicing areas. The CPS shrouds can be used as a harness datum, due to the integrated cable tie/fir tree facility. The strong construction allows for the protection of delicate connections, or as an alternative when an interface / backshell isn't available. These fittings are designed to snap together over all types of Harnessflex slit and unslit conduit, maintaining maximum conduit bore.

### CPS Protective shroud

Part No.	Internal diameter (mm)	Conduit size (NC)		Conduit size (NW)		Nominal dimensions (mm)				
		A	B	A	B	C	D	E	F	G
CPS341212	35	12	12	10	10	38.0	73.0	100.0	10.0	10.0
CPS421212	43	12	12	10	10	47.0	77.0	104.0	10.0	10.0
CPS421616	43	16	16	13	13	47.0	77.0	104.0	10.0	10.0
CPS422020	43	20	20	17	17	47.0	77.0	104.0	12.0	12.0

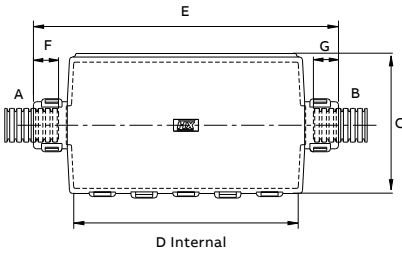

# MPS Custom fittings

## Multiple breakout conduit fitting



### Custom multiple breakout fitting

Designed to suit specific project or application requirements. Custom configurations available on request, (volume dependant).

### MPS Custom multiple breakouts

Part No.	Conduit size (NC)					Conduit size (NW)					Nominal dimensions (mm)							
	A	B	C	D	E	A	B	C	D	E	F	G	H	I	J	K	L	M
MPS121212-2020	12	12	12	20	20	10	10	10	17	17	10.0	7.0	10.0	10.0	10.0	59.0	92.0	32.0
MPS122812-2020	12	28	12	20	20	10	23	10	17	17	10.0	12.0	10.0	10.0	10.0	67.0	92.0	32.0
MPS201220-2020	20	12	20	20	20	17	17	10	17	17	12.0	7.0	12.0	10.0	10.0	59.0	92.0	32.0
MPS202820-2020	20	28	20	20	20	17	23	17	17	17	12.0	12.0	12.0	10.0	10.0	67.0	92.0	32.0
MPS251225-2020	25	12	25	20	20	22	10	22	17	17	11.0	7.0	11.0	10.0	10.0	59.0	92.0	32.0
MPS252825-2020	25	28	25	20	20	22	23	22	17	17	11.0	12.0	11.0	10.0	10.0	67.0	92.0	32.0

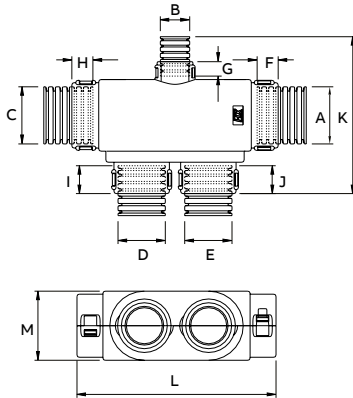

Part No.	Type	Conduit size (NC)						Conduit size (NW)					
		A	B	C	D	E	F	A	B	C	D	E	F
MPS100	1	12	8	20	20	25	12	10	7.5	17	17	22	10
MPS102	2	16	8	16	8	25	-	13	7.5	16	7.5	22	-

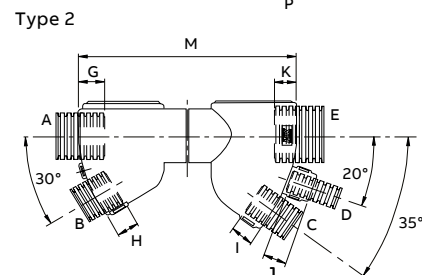
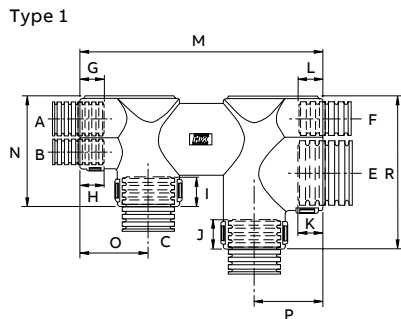

Part No.	Type	Conduit engagement										Nominal dimensions (mm)			
		G	H	I	J	K	L	M	N	O	P	R			
MPS100	1	10.0	10.0	12.0	12.0	13.0	12.0	98.0	43.0	28.0	28.0	59.0			
MPS102	2	10.0	10.0	10.0	10.0	13.0	-	97.0	-	-	-	-			

# CCSB Conduit clips

## Reducing closure clips for slit conduit

3-in-1 circular clips for slit conduit that offer up to 50% greater resistance to compression and mechanical strain.



CCSB conduit clips are designed to securely close slit conduit, preventing cable exposure. This reduces the risk of cable damage, improves crush strength of slit conduits and offers greater strain relief on all Harnessflex hinged fitting and conduit systems.

CCSB conduit clips are made from resilient PA66 material and provide additional compression strength to slit conduits. When applied, CCSB clips also help to maintain conduit integrity when strained, greatly reducing associated risks of gapping and severe damage to cables.



### Strain relief enhancing

Size	Average plain Y/T	Average Y/T with CCSB
NC12	88	97 (+10%)
NC16	51	72 (+41%)
NC20	62	64 (+3%)
NC25	160	175 (+9%)
NC32	147	193 (+31%)
NC40	72	100 (+38%)

Results: Average performance benefit +22%.

CCSB conduit clips also provide a reducing function for hinged fittings, allowing smaller conduits to be installed securely into larger conduit outlets. Some clips can be clipped together to offer further reducing options, allowing inventory to be maximised and providing greater product installation flexibility for global harness-makers.

### Features & benefits

- **Average strain relief increase by 22%**
  - for all hinged fittings on conduit / interface junction outlet
- **Average tensile strength (pull off) increase by 21%**
  - for all hinged fittings on conduit / interface junction outlet
- **3-in-1 multi-functional capabilities:**
  - Strengthens conduit - up to 50% greater resistance to compression
  - Provides greater strain relief - increases snap out performance of all backshells and hinged fittings
  - Facilitates numerous reducing options - enables size of conduit used within a standard fitting or backshell to be stepped down when needed
- External grooves to allow attachment of single piece fixing clips for ease of installation
- Securely closes slit conduit to prevent cable exposure
- Can be easily stacked to enable further reduction in conduit size
- Suitable for all Harnessflex slit and un-slit conduits

## CCSB Conduit clips

Reducing closure clips for slit conduit

### CCSB Conduit Clips

	Part No.	For conduit	Fits Outlet / CCSB Reducer	Nominal dimensions (mm)		
				A	B	C
	CCSB08	NC08 / NW7.5	NC16 / NW13 CCSB16	8.1	16.0	10.5
	CCSB10	NC10 / NW8.5	-	9.5	19.4	12.1
	CCSB12	NC12 / NW10	NC20 / NW17 CCSB20	9.5	20.8	13.6
	CCSB16	NC16 / NW13	NC20 / NW17 CCSB20	9.3	20.9	16.8
	CCSB20	NC20 / NW17	NC28 / NW23 CCSB28	9.0	27.8	21.7
	CCSB25	NC25 / NW22	NC32 / NW29 CCSB32	10.2	34.2	26.4
	CCSB28	NC28 / NW23	-	10.2	36.0	29.0
	CCSB32	NC32 / NW29	-	11.5	42.2	35.1
	CCSB40	NC40 / NW36	-	11.5	53.8	43.1
	CCSB50	NC50 / NW48	-	11.5	62.3	55.4

Colour: Black as standard.

### T-Piece + CCSB



### CCSB reduction options - Single clip outlet assembly



## Fitting accessories

### In-line circular fitting



#### In-line circular fitting

One-piece straight fittings providing in-line 'customised' combinations of multiple conduit breakouts. ST break out disk configuration can be made to order, for more details see website for specification and ordering sheet. NC08 outlets can be blanked off using BPST08.

### In-line hinged circular fitting

Part No.	Conduit size (A)		Nominal dimensions (mm)		
	NC	NW	B	C	D
CI20-A31	20	17	62	45	12
CI25-A31	25	22	62	45	13
CI32-A31	32	29	62	45	13

### Circular breakout fitting

Part No.	Beakout type					
	1	2	3	4	5	6
ST31-100	NC08	NC08	NC08	BLANK	NC08	NC08
ST31-101	NC12	NC12	NC08	BLANK	BLANK	NC12
ST31-102	NC08	NC08	NC08	NC08	NC08	NC08
ST31-103	NC12	NC12	NC12	NC12	NC12	NC12

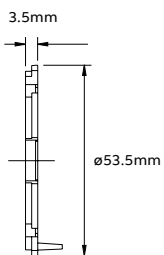



## Fitting accessories

### Multi-way reducers



#### Multi-way reducers

One-piece, multi-way breakout inserts providing reducing options to a variety of conduit sizes from a single fitting junction. These reducers can accommodate all types of Harnessflex slit and unslit conduit and may be used with all Harnessflex fittings.

#### 1. Split external design

Unrestricted bore and quick assembly - no tools required.

#### 2. Multiple configuration options

Provides the right conduit and outlet position option.

Multi-way reducers

	Part No.	TempGuard Part No	From conduit size		To conduit size (NC)					To conduit size (NW)				
			NC	NW	A	B	C	D	E	A	B	C	D	E
Multi-way reducer configurations Hinged fittings	ST20-2x08	STH20-2x08	20	17	08	08	-	-	-	7.5	7.5	-	-	-
	ST20-12	STH20-12	20	17	12	-	-	-	-	10	-	-	-	-
	STN25-3x08	STNH25-3x08	25	22	08	08	08	-	-	7.5	7.5	7.5	-	-
	ST25-12	STH25-12	25	22	12	08	-	-	-	10	-	-	-	-
	ST25-1208	STH25-1208	25	22	12	08	-	-	-	10	7.5	-	-	-
	ST28-4x08	STH28-4x08	28	23	08	08	08	08	-	7.5	7.5	7.5	7.5	-
	ST30-4x08	STH30-4x08	30	26	08	08	08	-	-	7.5	7.5	7.5	7.5	-
	ST32-12-4x08	STH32-12-4x08	32	29	12	08	08	08	08	7.5	7.5	7.5	7.5	7.5

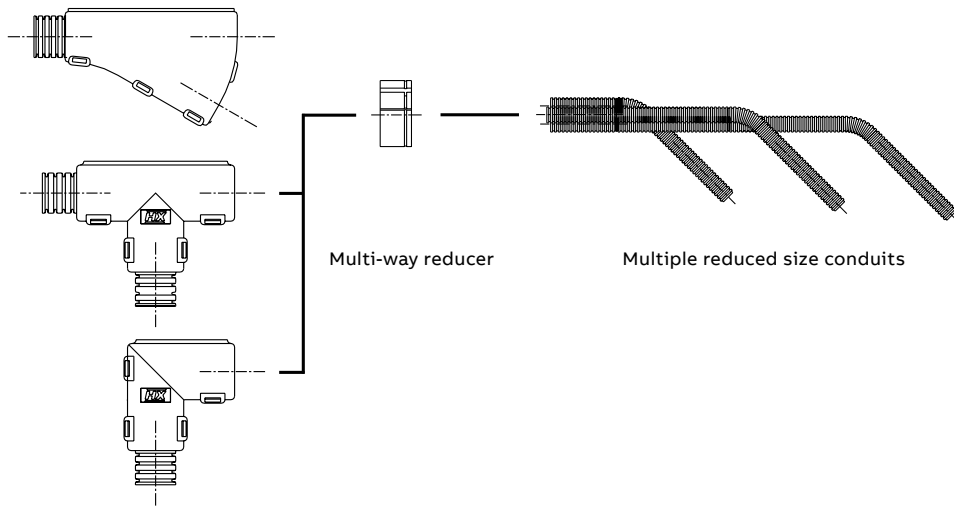
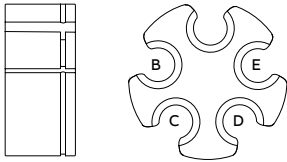

## Fitting accessories

### 06 Reducer



#### 06 Reducer

The 06 Reducer has been designed to seat in the conduit outlet of any 08 (NW 7.5) Harnessflex fitting. This enables the use of 06 (NW 4.5) conduit with fittings and makes possible, a full 06 size conduit cable protection system to include conduit, fittings and connector interfaces.

#### 06 Reducer - Part number listings

Part No.	Part No.	90° elbow Part No.	T & Y-Piece Part No.
CI06-AM2	RPS08-06	CI06-90-AM2	TPS060606
CI06-AS1		CI06-90-AS1	YPS060606
CI06-AS2		CI06-90-AS2	
CI06-AT2PL		CI06-90-AT2PL	
CI06-BC2		CI06-90-BC2	
CI06-DE001		CI06-90-DE001	
CI06-DT2		CI06-90-DT2	
CI06-DTX2		CI06-90-DTX2	
CI06-ES2P		CI06-90-ES2P	
CI06-ES2R		CI06-90-ES2R	
CI06-FCI02		CI06-90-FCI02	
CI06-MF2		CI06-90-MF2	
CI06-MMP2		CI06-90-MMP2	
CI06-MP2		CI06-90-MP2	
CI06-PTD2		CI06-90-PTD2	
CI06-SLK28-2		CI06-90-SLK28-2	
CI06-WP2		CI06-90-WP2	
CI06-WS2		CI06-90-WS2	





# Connector interfaces

## Providing high integrity connections

Harnessflex works closely with many OEMs to develop protection for electrical connectors (a critical area of an engine harness).

01 TE Ampseal 16 external connector interface.

External connector interfaces offer a compact and high integrity connection between automotive connectors and Harnessflex conduit systems. These interfaces provide complete cable protection right up to the connector. They also provide strain relief and protection from high pressure washing, helping to maintain the sealing integrity of the connector.

Products include:

- **External hinged connector interfaces** - Tough and durable protection for OEM connectors against high pressure wash-down, excessive cable strain and mechanical abrasion.
- **External split connector interfaces** - Split type customised interfaces providing high integrity connections to the Molex SRC series of connectors and Harnessflex conduit systems.
- **Special customised products** - Special hinged interfaces and blanking products.

Features & benefits include:

**1. High pull-off strength**

Internal conduit backstop provide insertion guide ensuring system integrity and high pull off strength.

**2. Conduit size labels**

Each junction indicates nominal conduit size to aid installation.

**3. Straight or 90° elbow versions**

Compact design ideal for use where space is limited. Allowing 360 degree rotation for ease of routing.



01

Ampseal 16 + Conduit

Conduit + Fitting



= Advanced performance system



## TE AMP Superseal

### Connector interface



#### TE AMP Superseal straight interface

	Connector reference	Interface reference	Part No.	TempGuard Part No.	Conduit size		Nominal dimensions (mm)		
					NC	NW	A	B	C
	282079-2*	1 way	CI06-AS1	CIH06-AS1	06	4.5	23.6	16.1	18.0
			CI08-AS1	CIH08-AS1	08	7.5	23.6	16.1	18.0
			CI12-AS1	CIH12-AS1	12	10	23.6	16.1	18.0
	282080-1*	2 way	CI06-AS2	CIH06-AS2	06	4.5	22.4	20.5	18.0
			CI08-AS2	CIH08-AS2	08	7.5	22.4	20.5	18.0
			CI10-AS2	CIH10-AS2	10	8.5	34.0	21.0	20.0
			CI12-AS2	CIH12-AS2	12	10	22.4	20.5	18.0
	282087-1*	3 way	CI08-AS3	CIH08-AS3	08	7.5	22.4	26.5	18.0
			CI10-AS3	CIH10-AS3	10	8.5	34.0	27.0	20.0
			CI12-AS3	CIH12-AS3	12	10	22.4	26.5	18.0
	282088-1*	4 way	CI08-AS4	CIH08-AS4	08	7.5	34.0	33.0	18.0
			CI10-AS4	CIH10-AS4	10	8.5	34.0	33.0	20.0
			CI12-AS4	CIH12-AS4	12	10	34.0	33.0	19.0

\*All Colour and Wire variants.

#### TE AMP Superseal 90° elbow swivel interface

	Connector reference	Interface reference	Part No.	TempGuard Part No.	Conduit size		Nominal dimensions (mm)		
					NC	NW	A	B	C
	282079-2*	1 way	CI06-90-AS1	CIH06-90-AS1	06	4.5	37.5	30.3	18.0
			CI08-90-AS1	CIH08-90-AS1	08	7.5	37.5	30.3	18.0
	282080-1*	2 way	CI06-90-AS2	CIH06-90-AS2	06	4.5	33.3	30.3	18.0
			CI08-90-AS2	CIH08-90-AS2	08	7.5	33.3	30.3	18.0
			CI10-90-AS2	CIH10-90-AS2	10	8.5	35.0	38.0	19.0
			CI12-90-AS2	CIH12-90-AS2	12	10	33.3	30.3	20.5
	282087-1*	3 way	CI08-90-AS3	CIH08-90-AS3	08	7.5	22.4	26.5	18.0
			CI10-90-AS3	CIH10-90-AS3	10	8.5	35.0	38.0	19.0
			CI12-90-AS3	CIH12-90-AS3	12	10	33.3	30.3	26.7
	282088-1*	4 way	CI08-90-AS4	CIH08-90-AS4	08	7.5	33.3	30.3	18.0
			CI10-90-AS4	CIH10-90-AS4	10	8.5	41.2	38.0	19.0
			CI12-90-AS4	CIH12-90-AS4	12	10	37.0	30.3	33.0

\*All Colour and Wire variants.

## TE AMP Junior & Mini timer

Connector interface



### TE AMP Junior & Mini timer straight interface

	Connector reference	Interface reference	Part No.	TempGuard Part No.	Conduit size		Nominal dimensions (mm)		
					NC	NW	A	B	C
	347887-3*	2 way	CI06-AM2	CIH06-AM2	06	4.5	24.9	21.3	18.0
			CI08-AM2	CIH08-AM2	08	7.5	24.9	21.3	18.0
			CI10-AM2	CIH10-AM2	10	8.5	37.0	21.0	19.0
			CI12-AM2	CIH12-AM2	12	10	24.9	21.3	18.0
	1-827578-1*	3 way	CI08-AM3	CIH08-AM3	08	7.5	24.9	27.2	18.0
			CI10-AM3	-	10	8.5	37.0	27.0	19.0
			CI12-AM3	CIH12-AM3	12	10	24.9	27.2	18.0
	281804-1*	4 way	CI08-AM4	CIH08-AM4	08	7.5	37.0	32	19.0
			CI10-AM4	-	10	8.5	37.0	32.0	19.0
			CI12-AM4	CIH12-AM4	12	10	37.0	32.0	19.0

\*All Colour and Wire variants.

### TE AMP Superseal 90° elbow swivel interface

	Connector reference	Interface reference	Part No.	TempGuard Part No.	Conduit size		Nominal dimensions (mm)		
					NC	NW	A	B	C
	347887-3*	2 way	CI06-90-AM2	CIH06-90-AM2	06	4.5	35.7	30.3	21.3
			CI08-90-AM2	CIH08-90-AM2	08	7.5	35.7	30.3	21.3
			CI10-90-AM2	CIH10-90-AM2	10	8.5	37.5	38.0	21.3
			CI12-90-AM2	CIH12-90-AM2	12	10	35.7	30.3	21.3
	1-827578-1*	3 way	CI08-90-AM3	CIH08-90-AM3	08	7.5	35.7	30.3	27.2
			CI10-90-AM3	CIH10-90-AM3	10	8.5	37.5	38.0	27.2
			CI12-90-AM3	CIH12-90-AM3	12	10	35.7	30.3	27.2
	281804-1*	4 way	CI08-90-AM4	CIH08-90-AM4	08	7.5	39.5	30.3	32.0
			CI10-90-AM4	CIH10-90-AM4	10	8.5	41.2	38.0	32.0
			CI12-90-AM4	CIH12-90-AM4	12	10	39.5	30.3	32.0

\*All Colour and Wire variants.

## TE Ampseal 16

### Connector interface



#### TE Ampseal 16 straight interface

	Connector reference	Interface reference	Part No.	TempGuard Part No.	Conduit size (A)		Nominal dimensions (mm)		
					NC	NW	B	C	D
	776427-1*	2 Way	CI06-AT2PL	CIH06-AT2P	06	4.5	23.0	18.0	34.0
			CI08-AT2PL	CIH08-AT2PL	08	7.5	23.0	18.0	34.0
	776427-1*	3 Way	CI08-AT3PL	CIH08-AT3PL	08	7.5	28.0	18.0	33.0
	776487-1*	4 Way	CI08-AT4PL	CIH08-AT4PL	08	7.5	29.0	23.0	39.0
			CI12-AT4PL	CIH12-AT4PL	12	10	29.0	23.0	37.0
	776433-1*	6 Way	CI12-AT6PL	CIH12-AT6PL	12	10	29.0	23.0	37.0
	776494-1*	8 Way	CI12-AT8PL	CIH12-AT8PL	12	10	32.0	23.0	37.0
			CI16-AT8PL	CIH16-AT8PL	16	13	32.0	23.0	37.0
	776494-1*	12 Way	CI12-AT12PL	CIH12-AT12PL	12	10	41.0	23.0	37.0
			CI16-AT12PL	CIH16-AT12PL	16	13	41.0	23.0	37.0
			CI20-AT12PL	CIH20-AT12PL	20	17	41.0	23.0	48.0

\*All Colour and Wire variants.

# TE Ampseal 16

## Connector interface (continued)

### TE Ampseal 16 90° elbow interface - Standard profile plugs

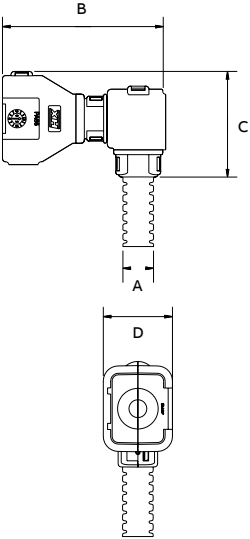

Connector reference	Interface reference	Part No.	TempGuard Part No.	Conduit size (A)		Nominal dimensions (mm)		
				NC	NW	B	C	D
776427-1*	2 Way	CI08-90-AT2PL	CIH08-90-AT2PL	08	7.5	49.0	32.0	20.0
		CI12-90-AT2PL	CIH12-90-AT2PL	12	10	49.0	32.0	20.0
776427-1*	3 Way	CI08-90-AT3PL	CIH08-90-AT3PL	08	7.5	49.0	34.0	20.0
		CI12-90-AT3PL	CIH12-90-AT3PL	12	10	49.0	34.0	20.0
776487-1*	4 Way	CI08-90-AT4PL	CIH08-90-AT4PL	08	7.5	53.0	34.0	23.0
		CI12-90-AT4PL	CIH12-90-AT4PL	12	10	53.0	35.0	23.0

\*All Colour and Wire variants.

### TE Ampseal 16 90° elbow interface - Standard profile plugs & caps

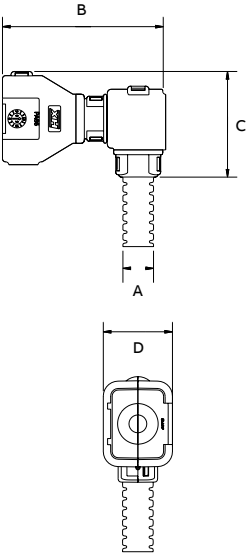

Connector reference	Interface reference	Part No.	TempGuard Part No.	Conduit size (A)		Nominal dimensions (mm)		
				NC	NW	B	C	D
<b>Standard profile plugs</b>								
776427-1*	2 way	CI06-90-AT2LP	-	06	4.5	37.3	25.0	17.0
		CI08-90-AT2LP	CIH08-90-AT2LP	08	7.5	37.3	25.0	17.0
		CI12-90-AT2LP	CIH12-90-AT2LP	12	10	38.0	23.0	20.0
776427-1*	3 way	CI08-90-AT3LP	CIH08-90-AT3LP	08	7.5	39.8	29.0	17.1
		CI12-90-AT3LP	CIH12-90-AT3LP	12	10	40.2	27.1	17.1
776487-1*	4 way	CI08-90-AT4LP	CIH08-90-AT4LP	08	7.5	40.8	29.4	20.6
		CI12-90-AT4LP	-	12	10	41.1	27.5	20.6
		CI16-90-AT4LP	-	16	12	-	-	-
776433-1*	6 way	CI08-90-AT6LP	CIH08-90-AT6LP	08	7.5	42.8	29.4	22.5
		CI12-90-AT6LP	CIH12-90-AT6LP	12	10	43.1	27.5	22.5
		CI16-90-AT6LP	-	16	13	-	-	-
<b>Standard profile caps</b>								
-	2 way	CI06-90-AT2LR	-	06	4.5	37.3	25.0	20.0
		CI08-90-AT2LR	CIH08-90-AT2LR	08	7.5	37.3	25.0	20.0
		CI12-90-AT2LR	-	12	10	38.0	23.0	20.0
-	3 way	CI08-90-AT3LR	CIH08-90-AT3LR	08	7.5	39.8	29.0	17.1
		CI12-90-AT3LR	CIH12-90-AT3LR	12	10	40.2	27.1	17.1
-	4 way	CI08-90-AT4LR	CIH08-90-AT4LR	08	7.5	40.8	29.4	20.6
		CI12-90-AT4LR	-	12	10	41.1	27.5	20.6
		CI16-90-AT4LR	-	16	13	41.1	27.5	20.6
-	6 way	CI08-90-AT6LR	CIH08-90-AT6LR	08	7.5	42.8	29.4	22.5
		CI12-90-AT6LR	-	12	10	43.1	27.5	22.5
		CI16-90-AT6LR	-	16	13	43.1	27.5	22.5

NOTE: LP = Plug, LR = Receptacle. \*All Colour and Wire variants.



## TE Econoseal Series

Backshell series for Econoseal J MK2 connectors



### TE Econoseal Series straight interface

	Connector reference	Interface reference	Part No.	TempGuard Part No.	Conduit size		Nominal dimensions (mm)		
					NC	NW	A	B	C
	<b>Plug</b>								
	174352-2*	2 Way	CI06-ES2P	CIH06-ES2P	06	4.5	35.1	17.4	14.7
			CI08-ES2P	CIH08-ES2P	08	7.5	35.1	17.4	14.7
	2822390-1*	3 Way	CI08-ES3P	CIH08-ES3P	08	7.5	34.9	22.9	14.7
	174257-2*	4 Way	CI10-ES4P	CIH10-ES4P	10	8.5	33.8	17.4	21.9
	<b>Receptacle</b>								
	174354-2*	2 Way	CI06-ES2R	CIH06-ES2R	06	4.5	41.5	23.6	23.4
			CI08-ES2R	CIH08-ES2R	08	7.5	41.5	23.6	23.4
	174359-2*	3 Way	CI08-ES3R	CIH08-ES3R	08	7.5	47.2	27.4	24.0
	174259-2*	4 Way	CI10-ES4R	CIH10-ES4R	10	8.5	42.3	23.6	30.0

Colour: Black as standard.

### TE Econoseal Series 90° elbow interface series

	Connector reference	Interface reference	Part No.	TempGuard Part No.	Conduit size		Nominal dimensions (mm)		
					NC	NW	A	B	C
	<b>Plug</b>								
	174352-2*	2 Way	CI06-90-ES2P	CIH06-90-ES2P	06	4.5	28.7	50.2	19.3
			CI08-90-ES2P	CIH08-90-ES2P	08	7.5	28.7	50.2	19.3
			CI10-90-ES2P	CIH10-90-ES2P	10	8.5	38.5	50.3	19.3
			CI12-90-ES2P	CIH12-90-ES2P	12	10	29.3	56.5	19.3
	2822390-1*	3 Way	CI08-90-ES3P	CIH08-90-ES3P	08	7.5	28.7	50.0	19.3
			CI10-90-ES3P	CIH10-90-ES3P	10	8.5	38.5	50.0	19.3
			CI12-90-ES3P	CIH12-90-ES3P	12	10	29.3	50.0	19.3
	174257-2*	4 Way	CI10-90-ES4P	CIH10-90-ES4P	10	8.5	38.5	49.3	21.9
			CI12-90-ES4P	CIH12-90-ES4P	12	10	29.3	49.2	21.9
		CI16-90-ES4P	CIH16-90-ES4P	16	13	33.6	50.2	21.9	
	<b>Receptacle</b>								
	174354-2*	2 Way	CI06-90-ES2R	CIH06-90-ES2R	06	4.5	28.7	56.5	23.4
			CI08-90-ES2R	CIH08-90-ES2R	08	7.5	28.7	56.5	23.4
			CI10-90-ES2R	CIH10-90-ES2R	08	7.5	38.5	56.5	23.4
			CI12-90-ES2R	CIH12-90-ES2R	12	10	29.3	56.5	23.4
	174359-2*	3 Way	CI08-90-ES3R	CIH08-90-ES3R	08	7.5	28.7	61.0	24.0
			CI10-90-ES3R	CIH10-90-ES3R	10	8.5	38.5	61.0	24.0
			CI12-90-ES3R	CIH12-90-ES3R	12	10	29.3	61.0	24.0
	174259-2*	4 Way	CI10-90-ES4R	CIH10-90-ES4R	10	8.5	38.5	56.4	30.0
			CI12-90-ES4R	CIH12-90-ES4R	12	10	29.3	56.3	30.0
		CI16-90-ES4R	CIH16-90-ES4R	16	13	33.6	58.3	30.0	

Colour: Black as standard.

## TE/Deutsch - DT Series

### Connector interface



#### TE/Deutsch - DT Series straight interface

	Connector reference	Interface reference	Part No.	TempGuard Part No.	Conduit size		Nominal dimensions (mm)		
					NC	NW	A	B	C
	DT06-2S*	2 way	CI06-DT2	CIH06-DT2	06	7.5	26.0	16.0	18.0
			CI08-DT2	CIH08-DT2	08	7.5	26.0	16.0	18.0
			CI12-DT2	CIH12-DT2	12	10	26.0	16.0	18.0
	DT06-3S*	3 way	CI08-DT3	CIH08-DT3	08	7.5	30.0	22.0	24.0
			CI12-DT3	CIH12-DT3	12	10	29.0	22.0	24.0
	DT06-4S*	4 way	CI08-DT4	CIH08-DT4	08	7.5	42.0	18.0	27.0
			CI12-DT4	CIH12-DT4	12	10	40.0	18.0	27.0
	DT06-6S*	6 way	CI08-DT6	CIH08-DT6	08	7.5	42.0	22.0	27.0
			CI12-DT6	CIH12-DT6	12	10	40.0	22.0	27.0
	DT06-8SA*	8 way	CI12-DT8	CIH12-DT8	12	10	40.0	25.0	30.0
	DT06-12SA*	12 way	CI16-DT12	CIH16-DT12	16	13	44.0	24.0	40.0

\*All colour and wire variants.

#### TE/Deutsch - DT Series 90° elbow swivel interface

	Connector reference	Interface reference	Part No.	TempGuard Part No.	Conduit size		Nominal dimensions (mm)		
					NC	NW	A	B	C
	DT06-2S*	2 Way	CI06-90-DT2	CIH06-90-DT2	06	7.5	36.0	30.0	19.0
			CI08-90-DT2	CIH08-90-DT2	08	7.5	36.0	30.0	19.0
			CI12-90-DT2	CIH12-90-DT2	12	10	36.0	30.0	19.0
	DT06-3S*	3 Way	CI08-90-DT3	CIH08-90-DT3	08	7.5	44.0	30.0	23.0
			CI12-90-DT3	CIH12-90-DT3	12	10	44.0	30.0	23.0
	DT06-4S*	4 Way	CI08-90-DT4	CIH08-90-DT4	08	7.5	48.0	30.0	25.0
			CI12-90-DT4	CIH12-90-DT4	12	10	48.0	30.0	25.0
	DT06-6S*	6 Way	CI08-90-DT6	CIH08-90-DT6	08	7.5	48.0	34.0	25.0
			CI12-90-DT6	CIH12-90-DT6	12	10	48.0	34.0	25.0
	DT06-8S*	8 Way	CI12-90-DT8	CIH12-90-DT8	12	10	63.0	37.0	30.0
	DT06-12SA*	12 Way	CI16-90-DT8	CIH16-90-DT8	16	13	63.0	37.0	30.0
	DT06-12SA*	12 Way	CI12-90-DT12	CIH12-90-DT12	12	10	68.0	36.0	38.0
	DT06-12SA*	12 Way	CI16-90-DT12	CIH16-90-DT12	16	13	68.0	36.0	38.0

\*All colour and wire variants.

## TE/Deutsch - DTP04 & DRC50 Series

### Connector interface



TE/Deutsch - DTP04 Series 90° elbow interface

Connector reference	Part No.	Conduit size (A)		Nominal dimensions (mm)		
		NC	NW	B	C	D
DTP06-4S-CE02	CI12-90-DTP04	12	10	27.0	37.0	25.0
DTP06-4S-E004	16-90-DTP04	–	–	27.0	37.0	25.0

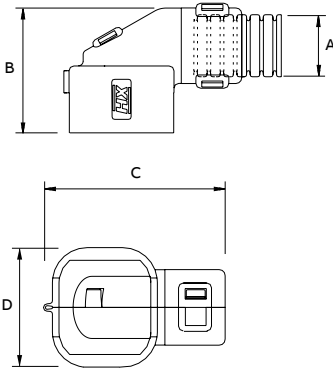

TE/Deutsch - DRC50 Series interface

Connector reference	Part No.	Conduit size (NC)				Conduit size (NW)		Nominal dimensions (mm)		
		A	B	C	D	E	F	G	H	I
DRC26-50S0*	CI122812-DRC50	12	28	12	10	23	10	58.0	92.0	36.0
DRC26-50S0*	CI201220-DRC50	20	12	20	17	10	17	50.0	92.0	36.0
DRC26-50S0*	CI202820-DRC50	20	28	20	17	23	17	58.0	92.0	36.0
DRC26-50S0*	CI251225-DRC50	25	12	25	22	10	22	50.0	92.0	36.0
DRC26-50S0*	CI252825-DRC50	25	28	25	22	23	22	58.0	92.0	36.0

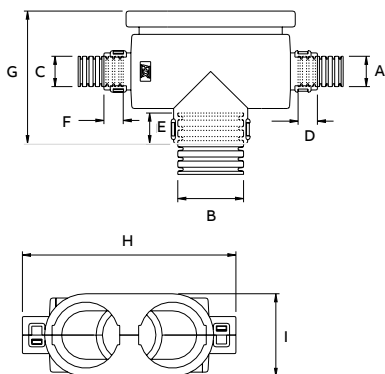

\* Original connector.

## FCI Automotive Apex 2.8

### Connector interface



#### FCI Automotive Apex 2.8 straight interface

	Connector reference	Interface reference	Part No.	TempGuard Part No.	Conduit size (A)		Nominal dimensions (mm)		
					NC	NW	B	C	D
	54200210	2 Way	CI06-FCI02	CIH06-FCI02	08	7.5	25.0	17.0	33.0
			CI08-FCI02	CIH08-FCI02	08	7.5	25.0	17.0	33.0
			CI12-FCI02	CIH12-FCI02	12	10	25.0	17.0	27.0
	54200312	3 Way	CI08-FCI03	CIH08-FCI03	08	7.5	34.0	17.0	34.0
			CI12-FCI03	CIH12-FCI03	12	10	35.0	17.0	29.0
	54200413	4 Way	CI08-FCI04	CIH08-FCI04	08	7.5	39.0	17.0	34.0
			CI12-FCI04	CIH12-FCI04	12	10	38.0	17.0	29.0
	54201415	14 Way	CI12-FCI14	CIH12-FCI14	12	10	53.0	26.0	34.0
			CI16-FCI14	CIH16-FCI14	16	13	53.0	26.0	59.0
			16-FCI14	H16-FC14	16	13	53.0	26.0	33.0
	DTB 5000 MH	50 Way	CI25-FCI50	-	25	22	56.0	37.0	50.7

#### FCI Automotive Apex 2.8 90° elbow swivel interface

	Connector reference	Interface reference	Part No.	TempGuard Part No.	Conduit size (A)		Nominal dimensions (mm)		
					NC	NW	B	C	D
	54200210	2 Way	CI06-90-FCS02	CIH06-90-FCS02	06	4.5	30.0	19.0	33.0
			CI08-90-FCS02	CIH08-90-FCS02	08	7.5	30.0	19.0	33.0
			CI06-90-FCI02	CIH06-90-FCI02	06	4.5	31.0	19.0	48.0
			CI08-90-FCI02	CIH08-90-FCI02	08	7.5	31.0	19.0	48.0
			CI12-90-FCI02	CIH12-90-FCI02	12	10	32.0	19.0	48.0
	54200312	3 Way	CI08-90-FCI03	CIH08-90-FCI03	08	7.5	35.0	19.0	49.0
			CI12-90-FCI03	CIH12-90-FCI03	12	10	37.0	19.0	49.0
	54200413	4 Way	CI08-90-FCI04	CIH08-90-FCI04	08	7.5	38.0	19.0	49.0
			CI12-90-FCI04	CIH12-90-FCI04	12	10	38.0	19.0	49.0
	54201415	14 Way	CI08-90-FCI14	CIH08-90-FCI14	08	7.5	38.0	24.0	57.0
			CI12-90-FCI14	CIH12-90-FCI14	12	10	38.0	24.0	57.0
			CI16-90-FCI14	CIH16-90-FCI14	16	13	38.0	24.0	57.0
			CI20-90-FCI14	CIH20-90-FCI14	20	17	32.9	23.5	63.7

# Bosch Compact

## Connector interface



### Bosch Compact straight interface

	Connector reference	Interface reference	Part No.	TempGuard Part No.	Conduit size		Nominal dimensions (mm)		
					NC	NW	A	B	C
	1 928 403 137*	2 Way	CI06-BC2	CIH06-BC2	06	7.5	25.0	21.3	18.0
			CI08-BC2	CIH08-BC2	08	7.5	25.0	21.3	18.0
			CI12-BC2	CIH12-BC2	12	10	25.0	21.3	18.0
	1 928 403 110*	3 Way	CI08-BC3	CIH08-BC3	08	7.5	25.0	26.7	18.0
			CI12-BC3	CIH12-BC3	12	10	25.0	26.7	18.0
	1 928 403 112*	4 Way	CI08-BC4	CIH08-BC4	08	7.5	25.0	29.0	18.0
			CI12-BC4	CIH12-BC4	12	10	25.0	29.0	18.0
	-	40 Way	CI28-BC40	CIH28-BC40	28	23	44.4	40.0	-

ø Conduit

\*All Bosch Kompact variants.

### Bosch Compact 90° elbow swivel interface

	Connector reference	Interface reference	Part No.	TempGuard Part No.	Conduit size		Nominal dimensions (mm)		
					NC	NW	A	B	C
	1 928 403 137*	2 Way	CI06-90-BC2	CIH06-90-BC2	06	7.5	33.3	30.3	20.5
			CI08-90-BC2	CIH08-90-BC2	08	7.5	33.3	30.3	20.5
			CI12-90-BC2	CIH12-90-BC2	12	10	33.3	30.3	20.5
	1 928 403 110*	3 Way	CI08-90-BC3	CIH08-90-BC3	08	7.5	33.3	30.3	26.7
			CI12-90-BC3	CIH12-90-BC3	12	10	33.3	30.3	26.7
	1 928 403 112*	4 Way	CI08-90-BC4	CIH08-90-BC4	08	7.5	37.0	30.3	33.0
			CI12-90-BC4	CIH12-90-BC4	12	13	37.0	30.3	33.0

ø Conduit

\*All Bosch Kompact variants.

## Kostal

Kostal 90° elbow swivel interface, straight interface & PG thread LK20



### Kostal hinged interface

Clip-on elbow interface for Kostal in-line connector.

### Kostal 90° elbow swivel interface

	Connector reference	Interface reference	Part No.	Conduit size (A)		Nominal dimensions (mm)		
				NC	NW	B	C	D
	9442291	2 way	CI08-90-K2C	08	7.5	27.4	30.0	19.5
			CI12-90-K2C	12	10	27.4	31.0	19.5
	9302231	3 way	CI08-90-K3C	08	7.5	27.4	31.4	19.5
			CI12-90-K3C	12	10	27.4	32.4	19.5
	9331031	10 way	CI12-90-K10C	12	10	38.4	37.7	19.5

### Kostal straight interface

	Connector reference	Interface reference	Part No.	Conduit size (A)		Nominal dimensions (mm)		
				NC	NW	B	C	D
	9430010	20 Way	CI16-LK20	16	13	51.0	28.0	34.0
			9441391	28 Way	CI08-SLK28-3	08	7.5	51.0

### PG thread LK20

Part No.	Thread type	Thread length (mm)	A/F (mm)	I.D (mm)
PG21-LK20	PG21	12.2	37.8	22.6

## Kostal SLK Series

Backshell series for Kostal SLK connector



**Compatible with conduit types:**

Kostal SLK 2,8 Series

### Kostal SLK Series 180° straight interface

	Connector reference	Interface reference	Part No.	Conduit size		Nominal dimensions (mm)		
				NC	NW	A	B	C
	09-4440-2*	2 Way	CI06-SLK28-2	06	4.5	23.8	34.5	16.5
				08	7.5	23.8	34.5	16.5
	09-4440-3*	3 Way	CI08-SLK28-3	08	7.5	30.2	36.1	16.5

### Kostal SLK Series 90° elbow interface - 2 part swivel

	Connector reference	Interface reference	Part No.	Conduit size		Nominal dimensions (mm)		
				NC	NW	A	B	C
	09-4440-2*	2 Way	CI06-90-SLK28-2	06	4.5	30.0	48.5	19.5
				08	7.5	30.0	48.5	19.5
	09-4440-3*	3 Way	CI08-90-SLK28-3	08	7.5	33.2	50.0	19.5
				09-4440-3*	4 Way	CI12-90-SLK28-4	12	10

## Aptiv Series

### External connector interface



#### Aptiv Series straight interface

	Connector reference	Interface reference	Part No.	Conduit size		Nominal dimensions (mm)		
				NC	NW	A	B	C
	12162194	2 way	CI08-MP2	08	7.5	20.0	16.0	28.9
	12162852		CI08-MMP2	08	7.5	30.0	17.0	18.0
	12015792	CI08-WP2	08	7.5	31.3	16.1	28.3	
	15397337/ 15397327	3 way	CI08-PTD2	08	7.5	20.2	20.5	18.0
	13532244		CI06-DE001	08	7.5	18.0	17.0	17.0
	15300003		CI06-MP2	08	7.5	20.0	16.0	28.9
	15336121		CI06-MMP2	08	7.5	30.0	17.0	18.0
	15326631		CI06-WP2	08	7.5	31.3	16.1	28.3
			CI06-PTD2	08	7.5	20.2	20.5	18.0
			CI08-DE001	08	7.5	18.0	17.0	17.0
			CI08-MP3	08	7.5	43.0	20.0	28.0
			CI08-GT153	08	7.5	38.0	24.0	16.0
	16-GT284	16	13	37.3	21.3	40.0		

#### External straight connector interface

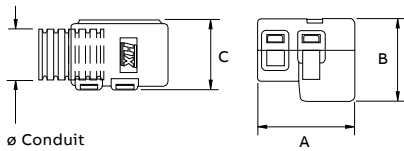



# Aptiv Series

## External connector interface (continued)

### Aptiv Series 90° elbow swivel interface

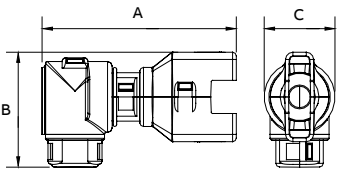
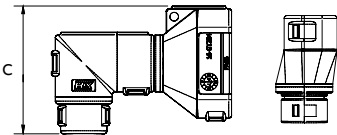
	Connector reference	Interface reference	Part No.	Conduit size		Nominal dimensions (mm)			
				NC	NW	A	B	C	
	12162194	2 way	CI08-90-MP2	08	7.5	35.0	42.0	29.5	
	12162852		CI08-90-MMP2	08	7.5	45.0	30.0	19.0	
	12162194		CI12-90-MP2	12	10	20.0	42.0	30.5	
	12162852		CI12-90-MMP2	12	10	-	-	-	
	12052613/ 12065863*		CI08-90-WP2	08	7.5	45.2	33.3	19.5	
	15397337/ 15397327		CI12-90-WP2	12	10	45.2	34.3	19.5	
	15397337/ 15397327		CI08-90-PTD2	08	7.5	33.8	30.0	22.0	
	13532244		CI12-90-PTD2	12	10	33.8	21.0	22.0	
		13532244	3 way	CI06-90-MP2	08	7.5	35.0	42.0	29.5
				CI06-90-MMP2	08	7.5	45.0	30.0	19.0
			CI06-90-WP2	08	7.5	45.2	33.3	19.5	
			CI08-90-DE001	08	7.5	32.0	30.0	17.5	
			CI08-90-MP3	08	7.5	56.9	30.0	20.0	
			CI12-90-MP3	12	10	56.9	31.0	20.0	
			CI08-90-GT153	08	7.5	53.0	31.0	19.0	
			CI12-90-GT153	12	10	53.0	32.0	19.0	
			CI12-90-GT284	12	10	62.6	44.4	-	
			CI16-90-GT284	16	13	62.6	44.4	-	

### External elbow connector interface

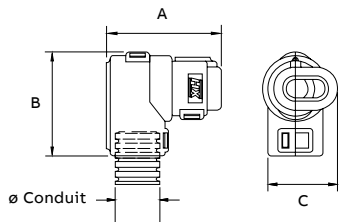

Part reference	Connector system	
MP	Delphi Metri-Pack	To suit Metripack
MMP	Delphi Metri-Pack	To suit Metripack
WP	Delphi Weatherpack	To suit Weatherpack
PTD	Power Timer	
GT	Delphi GT Series 150 and 180	

## Sumitomo

### 4 Way hinged interface



#### Sumitomo 4 way hinged interface

	Connector reference	Interface reference	Part No.	Conduit size (A)		Nominal dimensions (mm)		
				NC	NW	B	C	D
	6098-0144*	4 way	CI08-SU4	08	7.5	34.4	31.5	16.1
			CI08-90-SU4	08	7.5	48.2	34.8	19.3
	6195-0030**		CI08-X2SU4	08	7.5	34.0	29.2	16.1
			CI08-90-X2SU4	08	7.5	48.9	34.7	19.3
	6189-1134	10 way	CI12-SU10	12	10	30.8	26.9	16.1

NOTE: 180° versions are available.

\* Original connector.

\*\*New version of connector.

## DIN 72585 & Millflex ABS

### Hinged interfaces



DIN 72585 hinged interface

Part No.	Conduit size (A)		Nominal dimensions (mm)		
	NC	NW	B	C	D
CI08-72585	08	7.5	40.9	24.9	10.0

Millflex hinged ABS interface

Part No.	Conduit size (A)		Nominal dimensions (mm)
	NC	NW	B
CI06-MF2	08	7.5	35.6
CI08-MF2	08	7.5	35.6
CI10-MF2	10	8.5	35.6
CI12-MF2	12	10	35.6

## Special customised products

### Interfaces for circular connectors



#### Interfaces for circular connectors

Interface provides connection between electrical circular connectors and hinged conduit system. Due to the innovative design, the interface can freely rotate without any harness movement.

#### Hinged fitting

Part No.	Shell size (mm)	Conduit size		Thread size
		NC	NW	
NEPA14-16	14	16	13	13/16"-20 UNEF
NEPA16-20	16	20	17	15/16"-20 UNEF
NEPA24-28	24	28	23	17/16"-18 UNEF
CI20-CCU100	18/16	20	17	1"-20 UNEF
CI20-CCU119	18/16	20	17	13/16"-18 UNEF
CI28-CCU138	24	28	23	13/8"-18 UNEF

#### Interface for circular connector

Part No.	Shell size (mm)	Conduit size		Nominal dimensions (mm)			
		NC	NW	A	B	C	D
NEPA14-16	14	16	13	14.4	25.3	25.0	12.5
NEPA16-20	16	20	17	14.4	30.0	26.3	16.4
NEPA24-28	24	28	23	17.0	42.0	29.8	22.8
CI20-CCU100	18/16	20	17	11.0	30.0	26.0	16.4
CI20-CCU119	18/16	20	17	11.0	33.0	26.0	16.5
CI28-CCU138	24	28	23	13.0	41.5	30.0	22.8



# Sealed fittings

## Introduction

Harnessflex sealed conduit fittings are designed to offer effective stable joints and connections in a wiring harness, that also shield against high pressure wash-down, excessive dust ingress, cable strain and mechanical abrasion.

### Capabilities

Harnessflex offers complete system solutions for the routing and protection of electrical wiring against damage by impact, mechanical abrasion, liquid ingress and corrosive salts. Using a Harnessflex conduit system ensures that vulnerable connectors are not exposed to the elements, impact of foreign bodies or jet washing, all of which can cause vehicle malfunction and failure.

Featuring a unique vibration friendly profile (VFP) as standard, as well as UV and heat stabilisation as standard, Harnessflex solid conduit systems provide 10-150% greater life expectancy in dynamic or vibrating applications, when compared with other products.

### Features & benefits

- The anti-vibration spring clips can be released easily if access is needed - no tool required
- In order to maintain the IP rating of the sealed fittings face sealing washers must be used with all threaded fittings
- Our sealed T & X pieces and sealed manifolds have inspection covers, which can be removed during installation to aid cable routing

### Key features:

- 1 IP66, IP67, IP68 & IP69 sealing**  
SRN sealing bush protects against ingress of water and dust
- 2 Cap-nut retention ring**  
Ensures integrity of assembly under extreme vibration
- 3 Choice of threads (AB Straight fitting)**  
Available with metric, PG fixed male threads, NPT & PF
- 4 Includes flat seal washer**  
Provides seal between panel/bulkhead and fitting
- 5 90° Swept elbow / 90° Flange**  
Avoids cable damage and abrasion
- 6 Smooth contoured internal form**  
Protects cables from damage during installation
- 7 Integral mounting bracket**  
Provides secure external fixing point
- 8 Removable IP67 inspection lid**  
Provides easy access to cables during installation

### Sealed fittings

Approvals	IP Rating	Appropriate fitting	Temperature range	UV resistance
ADR Approved (NC conduits ONLY)		For use with: All conduits in the Harnessflex range	-40°C to +150°C	Very high
CE Mark to the Low Voltage Directive			<b>Fire performance</b>	
RoHS Compliant to 2011/65/EU	<b>IP66</b>	Yes	Self extinguishing	
Conforms with End of Life Vehicle directive (ELV) EU200/53/EC	<b>IP67</b>	Yes	Low smoke toxicity	
	<b>IP68</b>	Yes (2 bar 30mins)	Halogen free	
	<b>IP69</b>	Yes		



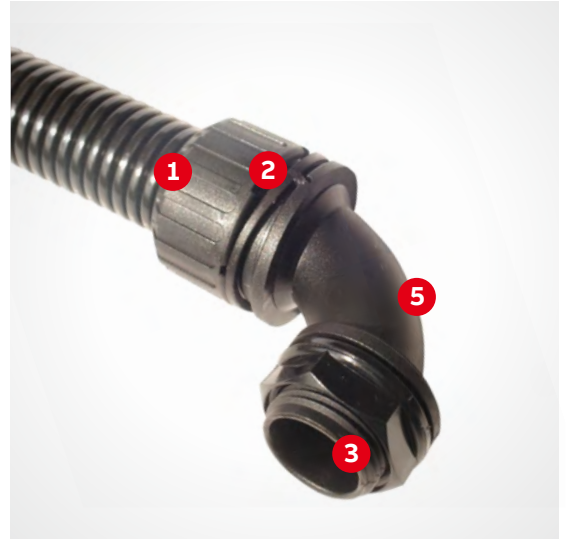

02



03



04

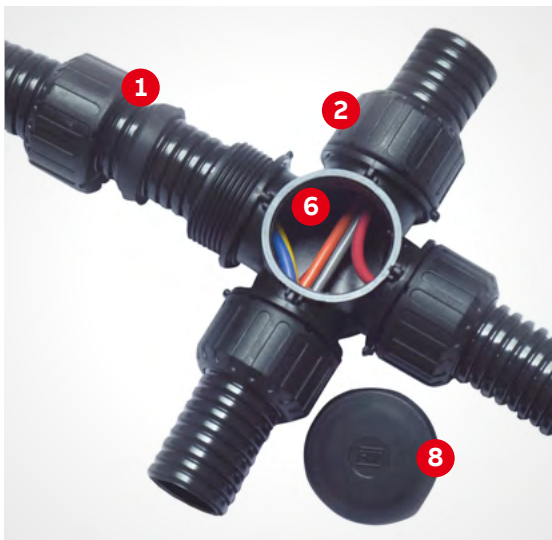

05



06

- 01 Straight - Sealed fitting.
- 02 90° Elbow - Sealed fitting.
- 03 90° Flange - Sealed fitting.
- 04 T-piece - Sealed fitting.
- 05 X-piece - Sealed fitting.
- 06 T-piece - Sealed fitting.

## Sealed fittings

Straight & 90° Elbow threaded fittings (Metric versions)



### Threaded fittings (Metric versions)

Straight and 90° Elbow compression type fittings incorporating fixed or swivel male threads to provide connection to knockouts and threaded entries. These fittings are designed for use with all types of unslit Harnessflex conduit, maintaining maximum conduit bore.

### Threaded fittings (Metric versions)

Metric thread	Conduit size		Straight	90° Elbow	Seal	Capnut	Configuration
	NC	NW					
M16	08	7.5	AB12-M16	-	RSB12-08	CN09-08	B
			AB16-M16	AB16-M16-90	RSB16-08	CN11-08	B
	10	8.5	AB12-M16	-	SRN07	CN07	A
	12	10	AB12-M16	-	SRN09	CN09	A
	16	12	AB16-M16	AB16-M16-90	RSB16-12	CN11-12	B
M20	08	7.5	AB12-M20	-	RSB12-08	CN09-08	B
			AB16-M20	AB16-M20-90	RSB16-08	CN11-08	B
			AB20-M20	AB20-M20-90	RSB20-08	CN16-08	B
	10	8.5	AB12-M20	-	SRN07	CN07	A
			AB16-M20	AB16-M20-90	RSB16-12	CN11-12	B
	12	10	AB12-M20	-	SRN09	CN09	A
			AB16-M20	AB16-M20-90	RSB16-12	CN11-12	B
			AB20-M20	AB20-M20-90	RSB20-12	CN16-12	B
			AB16-M20	AB16-M20-90	SRN11	CN11	A
16	12	AB20-M20	AB20-M20-90	RSB20-16	CN16-16-HF	B	
		AB20-M20	AB20-M20-90	SRN16	CN16	A	
M25	12	10	AB25-M25	AB25-M25-90	RSB28-12	CN21-12	B
	16	12	AB25-M25	AB25-M25-90	RSB28-16	CN21-16	B
	20	17	AB25-M25	AB25-M25-90	RSB28-20	CN21-20	B
	25	22	AB25-M25	AB25-M25-90	SRN21	CN21	A
	28	23	AB25-M25	AB25-M25-90	SRN28	CN28-HF	A
M32	20	17	AB32-M32	AB32-M32-90	RSB32-20	CN32-20	B
	25	22	AB32-M32	AB32-M32-90	RSB32-25	CN32-25	B
	28	23	AB32-M32	AB32-M32-90	RSB32-28	CN32-28	B
	32	29	AB32-M32	AB32-M32-90	SRN29	CN32	A
M40	40	36	AB40-M40	AB40-M40-90	SRN36	CN36-HF	A
M50	50	48	AB50-M50	AB50-M50-90	SRN48	CN47	A

NOTE: Order fitting bodies, cap nuts, sealing bushes separately.

### Configuration diagram





## Sealed fittings

### Straight & 90° Elbow threaded fittings (Metric versions)

#### Straight (Metric versions)

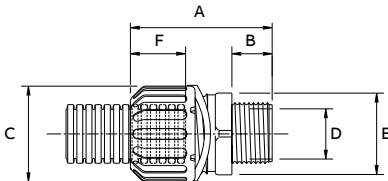
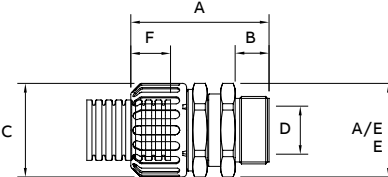
		Nominal dimensions (mm)							
		Straight body Part No.	A	B	C	Min bore D	A/F size E	F	
	Straight fitting	AB12-M16	34.0	12.0	23.0	11.0	22.0	17.0	
		AB12-M20	37.0	14.0	23.0	15.0	27.0	17.0	
		AB12-M16	34.0	12.0	26.0	11.0	22.0	17.0	
		AB12-M20	37.0	14.0	26.0	15.0	27.0	17.0	
		AB16-M16	35.0	12.0	26.0	11.0	27.0	17.0	
		AB16-M20	37.0	14.0	26.0	15.0	27.0	11.0	
		AB20-M20	39.0	14.0	31.0	15.0	30.0	20.0	
		AB25-M25	43.0	15.0	39.0	19.0	38.0	21.0	
		Straight swivel fitting	AB25-M25	43.0	15.0	39.0	19.0	38.0	21.0
			AB32-M32	49.0	16.0	46.0	26.0	46.0	27.0
		AB40-M40	59.0	16.0	58.0	31.0	59.0	35.0	
		AB50-M50	59.0	16.0	72.0	41.0	73.0	35.0	

NOTE: Dimensions refer to an overall assembly.

#### 90° Elbow (Metric versions)

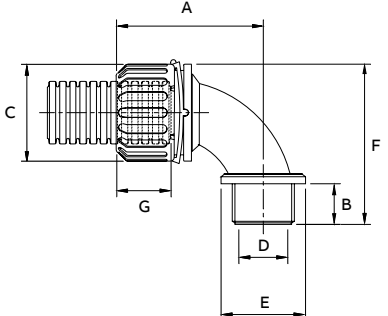
		Nominal dimensions (mm)							
		90° Elbow body Part No.	A	B	C	Min bore D	A/F size E	F	G
	90° elbow fitting	AB16-M16-90	46.0	12.0	26.0	15.0	22.0	48.0	17.0
		AB16-M20-90	46.0	13.0	26.0	15.0	27.0	49.0	17.0
		AB20-M20-90	47.0	13.0	31.0	15.0	27.0	51.0	20.0
		AB25-M25-90	56.0	15.0	39.0	20.0	33.0	62.0	21.0
		AB25-M25-90	56.0	15.0	39.0	20.0	33.0	62.0	21.0
		AB32-M32-90	66.0	16.0	46.0	26.0	40.0	76.0	27.0
		AB40-M40-90	77.0	16.0	59.0	34.0	48.0	93.0	35.0
		AB50-M50-90	94.0	16.0	72.0	40.0	59.0	114.0	35.0

NOTE: Dimensions refer to an overall assembly.

## Sealed fittings

Straight & 90° Elbow threaded fittings (PG versions)



### Threaded fittings (PG versions)

Straight and 90° Elbow compression type fittings incorporating fixed or swivel male threads to provide connection to knockouts and threaded entries. These fittings are designed for use with all types of unslit Harnessflex conduit, maintaining maximum conduit bore.

### Threaded fittings (PG versions)

PG thread	Conduit size		Straight	90° Elbow	Seal	Capnut	Configuration
	NC	NW					
PG09	08	7.5	AB12-PG09	AB12-PG09-90	RSB12-08	CN09-08	B
			AB16-PG09	-	RSB16-08	CN11-08	B
	10	8.5	AB12-PG09	AB12-PG09-90	SRN07	CN07	A
	12	10	AB12-PG09	AB12-PG09-90	SRN09	CN09	A
			AB16-PG09	-	RSB16-12	CN11-12	B
16	12	AB16-PG09	-	SRN11	CN11	A	
PG11	08	7.5	AB12-PG11	-	RSB12-08	CN09-08	B
			AB16-PG11	AB16-PG11-90	RSB16-08	CN11-08	B
	10	8.5	AB12-PG11	-	SRN07	CN07	A
	12	10	AB12-PG11	-	SRN09	CN09	A
			AB16-PG11	AB16-PG11-90	RSB16-12	CN11-12	B
16	12	AB16-PG11	AB16-PG11-90	SRN11	CN11	A	
PG13	08	7.5	AB12-PG13	-	RSB12-08	CN09-08	B
			AB16-PG13	-	RSB16-08	CN11-08	B
	10	8.5	AB12-PG13	-	SRN07	CN07	A
	12	10	AB12-PG13	-	SRN09	CN09	A
			AB16-PG13	-	RSB16-12	CN11-12	B
16	12	AB16-PG13	-	SRN11	CN11	A	
PG16	08	7.5	AB20-PG16	AB20-PG16-90	RSB20-08	CN16-08	B
	12	10	AB20-PG16	AB20-PG16-90	RSB20-12	CN16-12	B
	16	12	AB20-PG16	AB20-PG16-90	RSB20-16	CN16-16-HF	B
	20	17	AB20-PG16	AB20-PG16-90	SRN16	CN16	A
PG21	12	10	AB25-PG21	AB25-PG21-90	RSB28-12	CN21-12	B
	16	12	AB25-PG21	AB25-PG21-90	RSB28-16	CN21-16	B
	20	17	AB25-PG21	AB25-PG21-90	RSB28-20	CN21-20	B
	25	22	AB25-PG21	AB25-PG21-90	SRN21	CN21	A
	28	23	AB25-PG21	AB25-PG21-90	SRN28	CN28-HF	A
PG29	20	17	AB32-PG29	AB32-PG29-90	RSB32-20	CN32-20	B
	25	22	AB32-PG29	AB32-PG29-90	RSB32-25	CN32-25	B
	28	23	AB32-PG29	AB32-PG29-90	RSB32-28	CN32-28	B
	32	29	AB32-PG29	AB32-PG29-90	SRN29	CN32	A
PG36	40	36	AB40-PG36	-	SRN36	CN36-HF	A
PG48	50	48	AB50-PG48	-	SRN48	CN47	A

NOTE: Order fitting bodies, cap nuts, sealing bushes separately.

### Configuration diagram



## Sealed fittings

### Straight & 90° Elbow threaded fittings (PG versions)

#### Straight (PG versions)

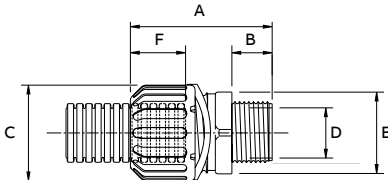
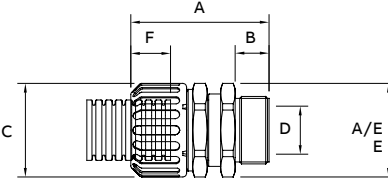
		Nominal dimensions (mm)						
		Part No.	A	B	C	Min bore D	A/F size E	F
	Straight fitting	AB12-PG09	32.0	10.0	23.0	10.0	22.0	17.0
		AB12-PG11	32.0	10.0	23.0	14.0	22.0	17.0
		AB12-PG13	32.0	10.0	23.0	16.0	22.0	17.0
		AB12-PG09	32.0	10.0	23.0	10.0	22.0	17.0
		AB12-PG11	32.0	10.0	23.0	14.0	22.0	17.0
		AB12-PG13	32.0	10.0	26.0	16.0	27.0	17.0
		AB16-PG09	32.0	10.0	26.0	10.0	27.0	17.0
		AB16-PG11	32.0	10.0	26.0	14.0	27.0	17.0
		AB16-PG13	32.0	10.0	26.0	16.0	27.0	17.0
		Straight swivel fitting	AB20-PG16	35.0	11.0	31.0	18.0	30.0
		AB25-PG21	40.0	12.0	39.0	23.0	38.0	21.0
		AB25-PG21	40.0	12.0	39.0	23.0	38.0	21.0
		AB32-PG29	45.0	12.0	46.0	31.0	46.0	27.0
		AB40-PG36	55.0	12.0	58.0	38.0	59.0	35.0
		AB50-PG48	55.0	12.0	72.0	50.0	73.0	35.0

NOTE: Dimensions refer to an overall assembly.

#### 90° Elbow (PG versions)

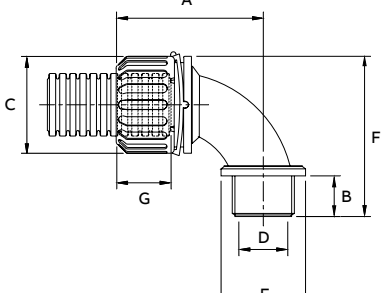
		Nominal dimensions (mm)							
		Part No.	A	B	C	Min bore D	A/F size E	F	G
	90° elbow fitting	AB12-PG09-90	46.0	10.0	23.0	11.0	22.0	44.0	17.0
		AB12-PG09-90	46.0	10.0	23.0	11.0	22.0	44.0	17.0
		AB16-PG11-90	46.0	10.0	26.0	14.0	25.0	46.0	17.0
		AB20-PG16-90	46.0	12.0	31.0	15.0	28.0	50.0	20.0
		AB25-PG21-90	56.0	12.0	39.0	22.0	36.0	59.0	21.0
		AB25-PG21-90	56.0	12.0	39.0	22.0	36.0	59.0	21.0
		AB32-PG29-90	66.0	12.0	46.0	29.0	44.0	72.0	27.0

NOTE: Dimensions refer to an overall assembly.

## Sealed fittings

### Circular UNEF connector



#### Circular UNEF connector

Straight compression type fittings providing connection between UNEF style circular connections and conduit systems. These fittings are designed for use with all types of unslit Harnessflex conduit, maintaining maximum conduit bore.

#### Threaded fittings (UNEF versions)

UNEF thread	Conduit size		Body	Seal	Capnut	Face seal	Configuration
	NC	NW					
5/8"-24 UNEF	08	7.5	MPA01	RSB12-08	CN09-08	SWPG07	B
	10	8.5	MPA01	SRN07	CN07	SWPG07	A
	12	10	MPA01	SRN09	CN09	SWPG07	A
3/4"-20 UNEF	08	7.5	MPA08	RSB12-08	CN09-08	SWPG09	B
	10	8.5	MPA08	SRN07	CN07	SWPG09	A
	12	10	MPA08	SRN09	CN09	SWPG09	A
13/16"-18 UNEF	08	7.5	MPA03	RSB20-08	CN16-08	SWPG16	B
	12	10	MPA03	RSB20-12	CN16-12	SWPG16	B
	16	12	MPA03	RSB20-16	CN16-16-HF	SWPG16	B
	20	17	MPA03	SRN16	CN16	SWPG16	A
1"-20 UNEF	08	7.5	MPA04	RSB20-08	CN16-08	SWM20	B
	12	10	MPA04	RSB20-12	CN16-12	SWM20	B
	16	12	MPA04	RSB20-16	CN16-16-HF	SWM20	B
	20	17	MPA04	SRN16	CN16	SWM20	A

NOTE: Order connector interface bodies, cap nuts, sealing bushes and sealing washers separately.

#### Circular UNEF connector interfaces

Interface body Part No.	Nominal dimensions (mm)				
	A	B	C	UNEF Thread D	E
MPA01	30.0	24.0	23.0	5/8"-24 UNEF	17.0
MPA03	33.0	36.0	31.0	1"-20 UNEF	20.0
MPA04	32.0	37.0	31.0	13/16"-18 UNEF	20.0
MPA08	30.0	32.0	23.0	3/4"-20 UNEF	17.0

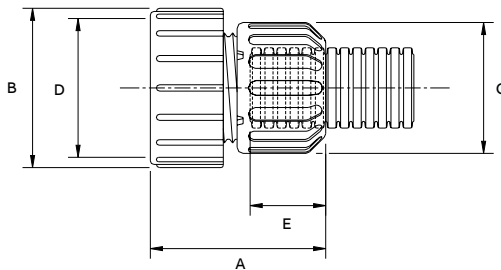

NOTE: Dimensions refer to overall assembly.

#### Configuration diagram



## Sealed fittings

### 90° Flange



#### 90° Flange

90° elbow compression type fitting providing a 4 hole panel mounting facility. These fittings are designed for use with all types of unslit Harnessflex conduit, maintaining maximum conduit bore.

#### 90° Flange

90° Flange Part No.	Conduit Size		Seal	Capnut	Configuration
	NC	NW			
AB32-F90	20	20	RSB32-20	CN32-20	B
	25	25	RSB32-25	CN32-25	B
	28	28	RSB32-28	CN32-28	B
	32	32	SRN29	CN32	A
AB40-F90	40	40	SRN36	CN36-HF	A
AB50-F90	50	50	SRN48	CN47	A

NOTE: Order flange bodies, cap nuts and sealing bushes separately.

#### Flange body

Flange body Part No.	Nominal dimensions (mm)									
	A	B	C	D	E	F	G	H	I	J
AB32-F90	66.0	54.0	46.0	36.0	95.0	36.0	17.0	63.0	53.0	27.0
AB40-F90	86.0	73.0	63.0	46.0	115.0	30.0	27.0	77.0	64.0	35.0
AB50-F90	86.0	73.0	73.0	59.0	125.0	30.0	30.0	86.0	77.0	35.0

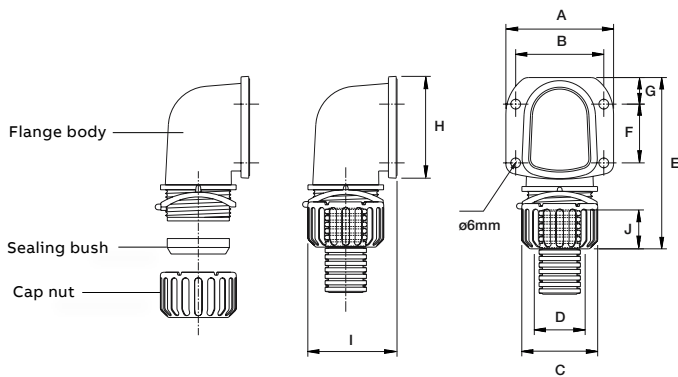

NOTE: Dimensions refer to overall assembly.

#### Configuration diagram



## Sealed fittings

T-Piece, X-piece & Multiway outlet manifolds



### T-piece

Symmetrical, 3 junction compression type fittings providing a variety of conduit size configurations.

### X-piece

Symmetrical 4 junction compression type fitting providing a variety of conduit size configurations.

### Multi-way fitting

Asymmetrical 4 junction compression fitting.

These fittings are designed for use with all types of unslit Harnessflex conduit, maintaining maximum conduit bore.

### Manifolds

Conduit size							
NC	NW	T-Body	X-Body	TPM-Body	Seal	Capnut	Configuration
08	7.5	TP12	-	TPM2512	RSB12-08	CN09-08	B
10	8.5		-		SRN07	CN07	A
12	10		-		SRN09	CN09	A
08	7.5	TP16	-	-	RSB16-08	CN11-08	B
12	12		-	-	RSB16-12	CN11-12	B
16	16		-	-	SRN11	CN11	A
8	8	TP20	XP20	-	RSB20-08	CN16-08	B
12	12			-	RSB20-12	CN16-12	B
16	16			-	RSB20-16	CN16-16-HF	B
20	20			-	SRN16	CN16	A
12	12	TP28	-	TPM2512	RSB25-12	CN21-12	B
16	16		-		RSB25-16	CN21-16	B
20	20		-		RSB25-20	CN21-20	B
25	25		-		SRN21	CN21	A
28	28		-		SRN28	CN28-HF	A
20	20	TP32	-	-	RSB32-20	CN32-20	B
25	25		-	-	RSB32-25	CN32-25	B
28	28		-	-	RSB32-28	CN32-28	B
32	32		-	-	SRN29	CN32	A

NOTE: Order manifold bodies, cap nuts and sealing bushes separately.

### Configuration diagram



## Sealed fittings

### T-Piece, X-piece & Multiway outlet manifolds

#### T-piece, X-piece & Mutiway manifolds

Manifold	With bracket Part No.	With no bracket	Nominal dimensions (mm)					
			A	B	C	D	E	F
T-Piece	-	TP12	-	68.0	50.0	39.0	27.0	17.0
	-	TP12	-	68.0	50.0	39.0	27.0	17.0
	-	TP16	-	69.0	51.0	38.0	31.0	17.0
	TPB20	TP20	-	80.0	58.0	43.0	35.0	20.0
	TPB28	TP28	-	95.0	71.0	52.0	43.0	21.0
	TPB28	TP28	-	95.0	71.0	52.0	43.0	21.0
	TPB32	-	-	109.0	84.0	61.0	51.0	27.0
X-Piece	XP20	-	-	80.0	-	80.0	35.0	20.0
Multiway	TPM2512	-	105	74.0	55.0	40.0	21.0	17.0

#### T-Piece

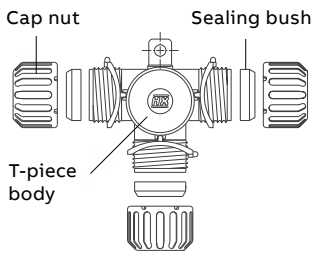

#### X-Piece

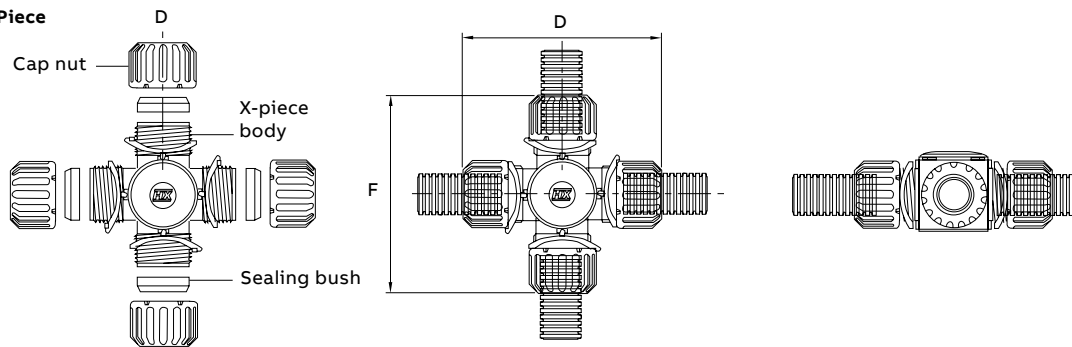

#### Multiway manifold

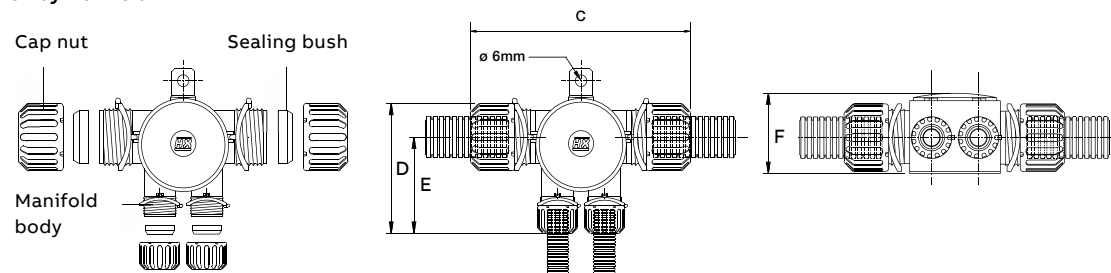

NOTE: Dimensions refer to overall assembly.

## Sealed fittings

### Solenoid connector

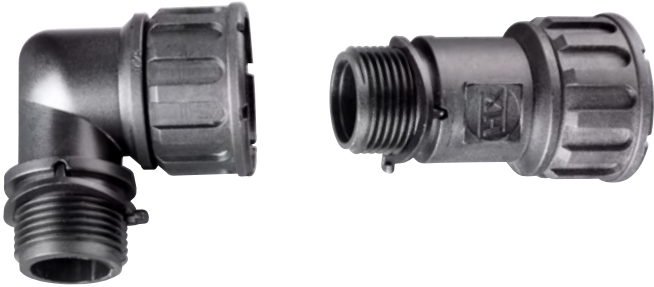

#### Solenoid connector

Screw-thread straight and elbow connectable interfaces for circular solenoids, sensors and switches. These fittings are designed for use with all types of unslit Harnessflex conduit, maintaining maximum conduit bore.

#### Solenoid connector

Solenoid connector Part No.	Conduit Size		Body	Seal	Capnut	Configuration
	NC	NW				
SC-M24-S	08	7.5	SC-M24-90	RSB12-08	CN09-08	B
	10	8.5	SC-M24-90	SRN07	CN07	A
	12	10	SC-M24-90	SRN09	CN09	A
SC-M27-S	08	7.5	SC-M27-90	RSB12-08	CN09-08	B
	10	8.5	SC-M27-90	SRN07	CN07	A
	12	10	SC-M27-90	SRN09	CN09	A

NOTE: Order solenoid bodies, cap nuts and sealing bushes separately.

#### Solenoid connector interfaces

Elbow fitting Part No.	Thread	Nominal dimensions (mm)				Nut colour
		A	B	C	D	
SC-M24-90	M24 x 1.0mm	31.3	8.5	40.5	Black	
SC-M27-90	M27 x 1.0mm	34.0	40.4	0.5	Grey	

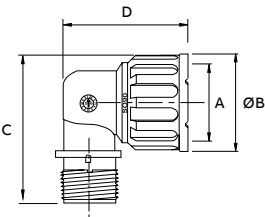

Straight fitting Part No.	Thread	Nominal dimensions (mm)				Nut colour
		A	B	C	D	
SC-M24-S	M24 x 1.0mm	31.0	53.0	-	Black	
SC-M27-S	M27 x 1.0mm	34.0	54.0	-	Grey	

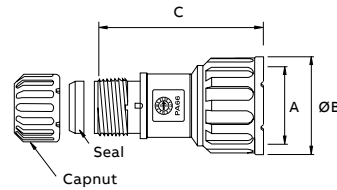

NOTE: Dimensions refer to overall assembly.

#### RSG Housing - Sealed fittings

Part No.	Suitable for connector type	Number of pins	Nominal dimensions (mm)			
			A	B	C	D
RSG02	M27	2	25.0	3.5	18.7	23
RSG03	M27	3	25.3	3.5	18.0	21
RSG04	M27	4	25.3	3.5	18.7	23
RSG05	M24	2	22.5	3.5	18.0	23
RSG06	M24	3	22.3	3.5	18.0	21

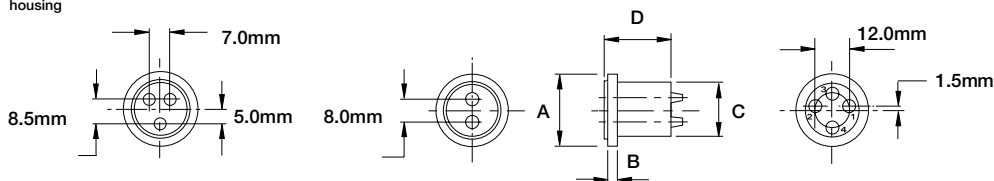
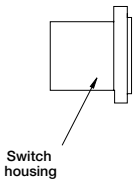





## Sealed fitting accessories

### Locknuts & Face sealing washers



**1. Protects cables from damage during installation**

With twin location points to assist fixing to conduit or connector.

**2. Internal location lip**

Provides internal protection during cable installation.

**3. Multiple cable carrying capacity**

Provides cable breakout facility in situations where sealing is not required.

#### Locknut

Part No.	Thread size	A (mm)	B (A/F) (mm)	Part No.	Colour	Thread size	A (mm)	B (A/F) (mm)
				LNP-PG07	●	PG07	5	19
LNP-M16	M16 x 1.5mm	7	19	LNP-PG09	●	PG09	5	22
LNP-M20	M20 x 1.5mm	8	23	LNP-PG11	●	PG11	5	24
LNP-M25	M25 x 1.5mm	9	28	LNP-PG13	●	PG13.5	6	27
LNP-M32	M32 x 1.5mm	9	36	LNP-PG16	●	PG16	6	30
LNP-M40	M40 x 1.5mm	10	46	LNP-PG21	●	PG21	7	36
LNP-M50	M50 x 1.5mm	10	60	LNP-PG29	●	PG29	7	46
				LNP-PG36	●	PG36	9	56
				LNP-PG48	●	PG48	9	59

#### Face sealing washer

Part No.	Thread	A (mm)	Part No.	Thread size	A (mm)
SWM16	M16	1.5	SWPG07	PG07	1.2
SWM20	M20	1.5	SWPG09	PG09	1.2
SWM25	M25	1.5	SWPG11	PG11	1.2
SWM32	M32	1.5	SWPG13	PG13.5	1.2
SWM40	M40	1.5	SWPG16	PG16	1.2
SWM50	M50	1.5	SWPG21	PG21	1.2
			SWPG29	PG29	1.2
			SWPG36	PG36	1.2
			SWPG48	PG48	1.2

#### End sleeve

Part No.	From conduit size		Outlet dia. range (C) (mm)	Nominal dimensions (mm)		
	NC	NW		A	B	D
ESN12	12	10	4 - 8	28	17	19
ESN16	16	13	5 - 9	35	17	23
ESN20	20	17	7 - 14	42	20	28
ESN25	25	22	9 - 17	50	21	31
ESN28	28	23	14 - 22	50	21	34
ESN32	32	29	16 - 32	53	27	40
ESN40	40	36	16 - 30	56	35	50

## Sealed fitting accessories

### Locknuts & Face sealing washers



**1. Swivel capability**

Converts sealed fittings into freely rotating IP40 fittings for dynamic applications.

**2. High pull-off strength**

Split C ring design sits tightly into conduit corrugations.

End cap

Part No.	From conduit size		Outlet dia. range (mm)	Nominal dimensions (mm)		
	NC	NW		A	B	C
EK03-08	08	7.5	3	19	13	14
EK03	08	7.5	3	19	13	14
EK05	12	10	5	22	14	17

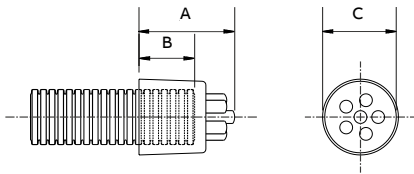

Smooth entry grommet

Part No.	From conduit size		A (mm)
	NC	NW	
SEG12	12	10	8
SEG20	20	17	16
GROM08	08	7.5	8
GROM12	12	10	12

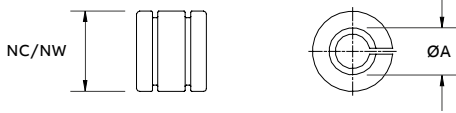

NOTE: Smoothbore. One piece slit insert providing abrasion protection for cables passing through a hinged junction where conduit is not used.

Smooth end cap

Part No.	From conduit size		Nominal dimensions (mm)		
	NC	NW	A	B	C
CES12	12	10	8.0	15	16
CES16	16	13	9.5	15	18
CES20	20	17	13.5	18	25
CES28	28	23	20.5	20	32
CES32	32	29	25.7	20	38

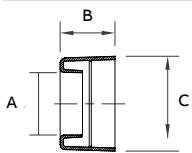

NOTE: Push in one piece fitting leaving a smooth exit from conduit when fittings not used.

## General accessories

### Conduit clip & Metallic P-clip



Conduit clip

#### Conduit clip

One piece non-metallic conduit clips providing secure mounting points for Harnessflex conduit systems. These fittings are designed to snap together over all types of Harnessflex slit and unslit conduit.

	Part No.	Conduit size A (mm)		Nominal dimensions (mm)					
		NC	NW	A	B	C	D	E	F
	HCB08	08	7.5	19.8	11.9	21.2	11.4	5.7	5.1
	HCB12	12	10	21.6	11.9	22.9	12.2	7.4	5.1
	HCB16	16	12	28.6	16.4	28.1	13.6	7.4	5.1
	HCB20	20	17	34.9	16.7	37.9	20.6	8.7	6.2
	HCB28	28	23	39.5	15.5	44.1	24.3	8.7	6.2
	HCB32	32	29	49.6	16.5	52.3	27.5	8.7	6.2
	HCB40	40	36	59.5	16.5	61.6	31.5	8.7	6.2
	HCB50	50	48	71.9	17.2	73.4	37.5	8.7	6.2



Metallic P-clip

#### Metallic P-clip

One-piece, metallic P-clips providing secure mounting points for conduit systems within a harness installation. These clips are designed to accommodate all Harnessflex slit and unslit conduits.

	Part No.	Conduit size (mm)		Fixing hole size (mm)				
		NC	NW	A	B	C	D	E
	PCS10	10	8.5	31	13	5	16	1.5
	PCS12	12	10	33	13	5	17	1.5
	PCS16	16	13	36	13	5	19	1.5
	PCS20	20	17	41	13	5	21	1.5
	PCS25	25	22	45	13	5	23	1.5
	PCS32	32	29	53	13	5	27	1.5

Materials: Galvanised steel with rubberised insert.

## General accessories

### Cable glands



#### Cable glands - Sealed fittings

Straight compression type cable glands incorporating fixed male threads to provide secure cable connections through knockouts and threaded entries.

#### Cable glands - Sealed fittings

Metric Part No.	Metric thread A	Cable OD range B (mm)	Nominal dimensions (mm)			
			C	D	E	F
CGS-M16	M16 x 1.5mm	4.0 - 10.0	9	34.5	21	23.5
CGS-M20	M20 x 1.5mm	6.0 - 12.0	10	37.0	24	27.0
CGS-M25	M25 x 1.5mm	13.0 - 18.0	11	40.0	30	33.0
CGS-M32	M32 x 1.5mm	17.0 - 25.0	12	49.0	41	45.5
CGS-M40	M40 x 1.5mm	24.0 - 32.0	13	55.0	50	55.5

PG Part No.	PG thread A	Cable OD range B (mm)	Nominal dimensions (mm)			
			C	D	E	F
CGS-PG07	PG7	2.0 - 6.5	8	31.0	17	19.0
CGS-PG09	PG9	4.0 - 10.0	8	33.5	21	23.5
CGS-PG11	PG11	6.0 - 12.0	8	35.0	24	27.0
CGS-PG13	PG13.5	6.0 - 12.0	9	36.0	24	27.0
CGS-PG16	PG16	10.0 - 14.0	10	38.5	27	30.0
CGS-PG21	PG21	13.0 - 18.0	11	40.0	30	33.0
CGS-PG29	PG29	17.0 - 25.0	11	48.0	41	45.5

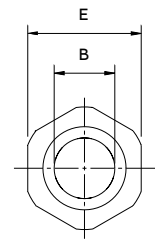
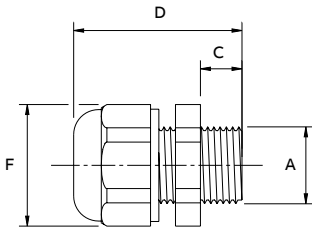

## Technical section

### Storage recommendation for polyamide products

**Polyamide is widely and successfully used for products in the electrical and electronics industries. Thanks to its excellent mechanical and physical properties over a wide range of application temperatures and its very good weather resistance, polyamide can be used to make products for interior and external use that meet the most stringent of demands.**

As a hygroscopic material, polyamide has the ability to absorb moisture in molecular form into the plastic matrix. As the moisture content goes up, product properties may change slightly. Absorbed water acts as a plasticiser reducing strengths and moduli and increasing the toughness of the polyamide.

Although at room temperature the stiffness and strength of PA6 is more reduced by the moisture uptake than those of PA66, this difference can be considered to be non-significant. PA6 absorbs more water than PA66, especially under high humidity conditions. But the resulting dimensional change is still of a similar order.

Figure 1 shows how the moisture content of polyamides comes into balance with the ambient air in a normal climate of 50% relative humidity and 23°C:

Material	In air (23°C / 50% rh)
Polyamide 6	3.0-3.5% by weight
Polyamide 66	2.5-3.0% by weight

To maintain balanced moisture content, Harnessflex recommends storing products under the following conditions:

Storage temp	Processing temp.	Rel. humidity
18°C to 30°C	>18°C	>30%

At lower processing temperatures and in particular when subjected to unnatural drying, corrugated pipes display increased flexural rigidity.

**Figure 1: Moisture content of polyamides**

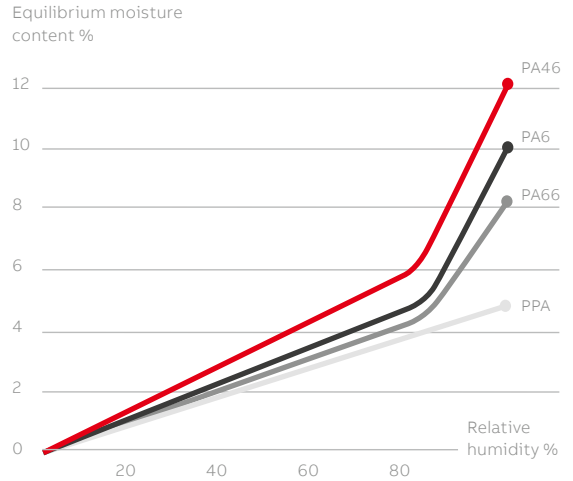

In the very dry winter months the moisture balance may go down slightly as the material releases moisture to the environment (owing to lower relative humidity). Compared to natural outdoor conditions\* at around 0°C (40... 80% rh), the humidity in heated rooms may drop by half to below 20% rh if no humidification is present. (Even extremely dry regions such as the Sahara Desert record average humidity of 20% to 60% rh) (\*Central European climate).

If products from an outside environment are brought into a heated processing area, the change in climate may suddenly cause temporary de-moisturisation around the edges. After one or two days in the processing area a natural balance will be restored.

Observing this storage recommendation ensures optimum processability and material properties.

## Ingress protection

### IEC 60529 IP Rating & NEMA 250 / UL50E Enclosures

IP suitability ratings are a system for classifying the degree of protection provided by enclosures of electrical equipment.

#### Protection against Solid Bodies

Degree of protection for persons against access to hazardous parts inside the enclosure and/or against the ingress of solid foreign objects.

	<b>0</b>	No protection
	<b>1</b>	Objects greater than 50 mm, accidental touch by hands
	<b>2</b>	Objects greater than 12 mm, accidental touch by fingers
	<b>3</b>	Objects greater than 2.5 mm, e.g. tools/wires
	<b>4</b>	Objects greater than 1 mm, e.g. tools/wires/small wires
	<b>5</b>	Protected against dust - limited ingress (no harmful deposits)
	<b>6</b>	Totally protected against dust (Dust-tight)

#### Protection against Water

Degree of protection of equipment inside enclosures against damage from the ingress of water.

	<b>0</b>	No protection
	<b>1</b>	Protected against vertically falling drops of water
	<b>2</b>	Protected against direct sprays of water 15° from vertical
	<b>3</b>	Protected against sprays of water to 60° from vertical
	<b>4</b>	Protected against water sprayed from all directions - limited ingress permitted
	<b>5</b>	Protected against low pressure jets of water from all directions - limited ingress permitted
	<b>6</b>	Protected against strong pressure jets of water, heavy seas - limited ingress permitted
	<b>7</b>	Protection against the effects of immersion between 15cm - 1 m
	<b>8</b>	Protection against long periods of immersion under a quoted pressure, e.g. 2 bar at 24 hours
	<b>9</b>	IP69 Automotive standard DIN40050 and signifies resistance to high pressure jets of water (up to 80bar) from any angle

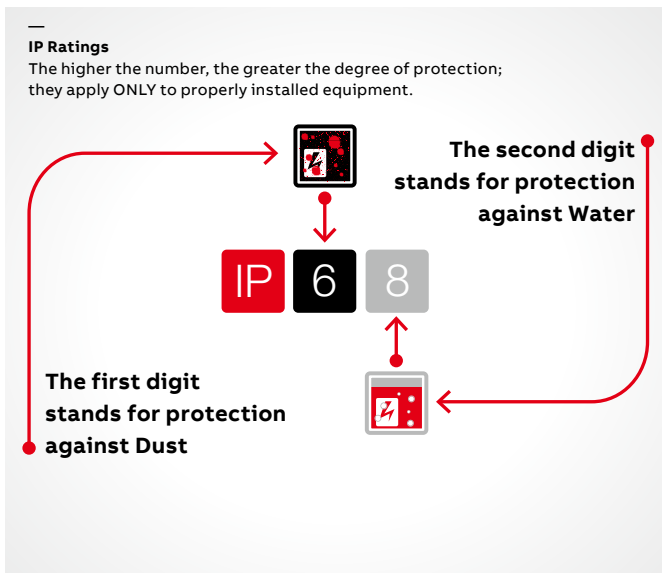

## Technical section

### Nylon (PA) 6

#### Nylon (PA) 6 - Material data sheet

Properties	Test method	Value	Unit
<b>General</b>			
Density	ISO 1183	1.13	g/cm <sup>3</sup>
Melting point	ISO 11357-1/-3	220	°C
<b>Mechanical</b>			
Tensile strength	ISO 527	55 (con)	MPa
Elongation at break	ISO 527	>50 (con)	%
Youngs modulus	ISO 527	3100 (Dry)	MPa
Charpy impact strength	ISO 179	DNB (Dry)	kJ/m <sup>2</sup>
Charpy notched impact strength	–	11 (Dry)	kJ/m <sup>2</sup>
IZOD impact strength	ISO 180C	DNB (Dry)	kJ/m <sup>2</sup>
IZOD notched impact strength	ISO 180A	4 (Dry)	kJ/m <sup>2</sup>
<b>Thermal</b>			
Heat distortion temperature-A	ISO 75	100	°C
Heat distortion temperature-B	ISO 75	>200	°C
<b>Flammability</b>			
Flammability	UL94	HB	N/A
<b>Electrical</b>			
Dielectric strength	IEC 243	14 (Dry)	MV/m
Surface resistivity	IEC 93	15 (Dry)	log10Ω
Volume resistivity	IEC 93	15 (Dry)	log10Ω
Comparative tracking index	IEC 112	>600	V

Used on: All Harnessflex NC and CTPA nylon conduits.

NOTE: All tests undertaken at 23°C where applicable.

#### Notes

- DNB = Did not break
- Dry = Dry as moulded
- Con = Conditioned 168hrs @ 23°C, 50% RH

#### Chemical resistance

Nylon 6 Harnessflex conduits are resistant to all underbonnet oils, greases, fuels, cleaning fluids and synthetic fluids. Like all Nylons they are resistant to weak acids but not resistant to strong or oxidizing acids.



## Technical section

### Nylon (PA) 66 - Heat stabilised

#### Nylon (PA) 66 - Heat Stabilised - Material data sheet

Properties		Test method	Value	Unit
<b>General</b>				
Density		ISO 1183	1.14	g/cm <sup>3</sup>
Melting point		ISO 1218	263	°C
<b>Mechanical</b>				
Tensile strength		ISO 527	95 (Dry)	MPa
Elongation at break		ISO 527	23 (Dry)	%
Youngs modulus		ISO 527	3400 (Dry)	MPa
Flexural modulus		ISO 178	2850 (Dry)	MPa
Charpy impact strength		ISO 179	DNB (Dry)	kJ/m <sup>2</sup>
Charpy notched impact strength		–	6 (Dry)	kJ/m <sup>2</sup>
IZOD impact strength		ISO 180C	DNB (Dry)	kJ/m <sup>2</sup>
IZOD notched impact strength		ISO 180A	5 (Dry)	kJ/m <sup>2</sup>
<b>Thermal</b>				
Heat distortion temperature-A	@1.8Mpa	ISO 75-2	85	°C
Heat distortion temperature-B	@ 0.45MPa	ISO 75-2	230	°C
<b>Flammability</b>				
Flammability		ISO 527	95 (Dry)	MPa
Glow wire flammability	@ 1.5mm	IEC 695-2-1/2	850 (Con)	°C
<b>Electrical</b>				
Dielectric strength		IEC 243	60 (Dry)	MV/m
Surface resistivity		IEC 60093	1E+15	Ω
Volume resistivity		IEC 60093	1E+15	Ω.cm
Comparative tracking index		IEC 60112	600	V

All Harnessflex un-reinforced nylon fittings.

NOTE: All tests undertaken at 23°C where applicable.

## Technical section

### Nylon (PA) 66 - 30% Glass fibre filled

#### Nylon (PA) 66 - 30% Glass Fibre Filled - Material data sheet

Properties	Test method	Value	Unit
<b>General</b>			
Density	ISO 1183	1.36	g/cm <sup>3</sup>
Moisture absorption <sup>(1)</sup>	Sim to ISO 62	1.6	%
<b>Mechanical <sup>(2)</sup></b>			
Tensile stress at yield/break <sup>(3)</sup>	ISO 527	195	N/mm <sup>2</sup>
Elongation at break ISO 527 3%	ISO 527	10000	N/mm <sup>2</sup>
Modulus of elasticity <sup>(4)</sup>			
IZOD notched impact strength	- @ +23°C	ISO 180/1A	13
	- @ -30°C 10 kJ/m <sup>2</sup>		
<b>Thermal</b>			
Heat deflection temperature (HDT)	ISO 75/A	250	°C
Ball pressure test	IEC 60695-10-2	> 200	°C
<b>Flammability</b>			
Flammability (1.6mm thickness)	UL94	HB	
Oxygen index	ISO4589	24	%
Glow wire test extinguishing time <sup>(5)</sup>	IEC60695-2-1/1	<15	s
Hot wire ignition (HWI) (1.5mm thickness)	IEC60695-2-20	>15	s
High current arc ignition (HAI) (0.7mm thickness)	IEC60947	>120	No of arcs
<b>Electrical <sup>(2)</sup></b>			
Dielectric strength	IEC 60243-1	>30	kV/mm
Specific surface resistivity	IEC 60093	10 <sup>15</sup>	Ω
Specific volume resistivity	IEC 60093	10 <sup>15</sup>	Ω.cm
Dielectric constant	- @ 100Hz	IEC60250	3.8
	- @ 1MHz		
Dissipation factor	- @ 100Hz	IEC60250	90
	- @ 1MHz		160
Comparative tracking index	IEC 60112	600	V
168h/100°C ref fuel B	-	+91	%

Used on: SC-M27 and SC-M24 Swivel nuts.

NOTE: All tests undertaken at 23°C where applicable.

(1) Moisture absorption, saturation at +23°C and 50% RH (ref. DIN53495).

(2) Dry as moulded.

(3) Test speed 5mm/min.

(4) Test speed 1mm/min.

(5) Glow wire applied during 30secs, temperature 750°C, thickness 1.6mm.

#### Notes

- DNB = Did not break
- Dry = Dry as moulded
- Con = Conditioned 168hrs @ 23°C, 50% RH

#### Chemical resistance

Polyamide (Nylon) 66 Harnessflex fittings are resistant to all underbonnet oils, greases, fuels, cleaning and synthetic fluids. Like all Nylons they are resistant to weak acids but not resistant to strong or oxidizing acids.

# Technical section

## Polyamide 46 (Nylon)

**Polyamide 46 (Nylon) – Heat and UV stabilised, Lubricated Used on: All Harnessflex TempGuard fittings.**

Properties	Test method	Value	Unit
<b>General</b>			
Density	ISO 1183	1140	kg/m <sup>3</sup>
Melting Point	ISO 11357	295	°C
<b>Mechanical</b>			
<b>Dry/cond</b>			
Yield Stress	ISO 527-1/-2	100 / 55	MPa
Yield Stress (120°C)	ISO 527-1/-2	50	MPa
Yield Stress (160°C)	ISO 527-1/-2	40	MPa
Yield Stress (180°C)	ISO 527-1/-2	35	MPa
Yield Stress (200°C)	ISO 527-1/-2	30	MPa
Nominal strain at break	ISO 527-1/-2	40 / >50	%
Nominal strain at break (120°C)	ISO 527-1/-2	>50	%
Nominal strain at break (160°C)	ISO 527-1/-2	>50	%
Nominal strain at break (180°C)	ISO 527-1/-2	>50	%
Nominal strain at break (200°C)	ISO 527-1/-2	>50	%
Tensile Modulus	ISO 527-1/-2	3300 / 1000	MPa
Tensile Modulus (120°C)	ISO 527-1/-2	800	MPa
Tensile Modulus (160°C)	ISO 527-1/-2	650	MPa
Tensile Modulus (180°C)	ISO 527-1/-2	600	MPa
Tensile Modulus (200°C)	ISO 527-1/-2	500	MPa
Flexural Modulus	ISO 178	300 / 900	MPa
Flexural Modulus (120°C)	ISO 178	800	MPa
Flexural Modulus (160°C)	ISO 178	600	MPa
Charpy impact strength (+23°C)	ISO 179/1eU	DNB / DNB	MPa
Charpy impact strength (-30°C)	ISO 179/1eU	DNB / DNB	MPa
Charpy notched impact strength (+23°C)	ISO 179/1eA	10 / 35	kJ/m <sup>2</sup>
Charpy notched impact strength (-30°C)	ISO 179/1eA	4 / 4	kJ/m <sup>2</sup>
Izod notched impact strength (+23°C)	ISO 180/1A	10 / 35	kJ/m <sup>2</sup>
Izod notched impact strength (-30°C)	ISO 180/1A	4 / 4	kJ/m <sup>2</sup>
<b>Thermal</b>			
Temp of deflection under load (1.80 Mpa)	ISO 75-1/-2	190	°C
Temp of deflection under load (0.45 Mpa)	ISO 75-1/-2	280	°C
<b>Flammability</b>			
Flammability (@1.5mm)	IEC60695-11-10	V2	N/A
Flammability (@0.75mm)	IEC60695-11-10	V2	N/A
<b>Electrical</b>			
Dielectric strength	IEC 60243-1	25 / 25	kV/mm
Volume Resistivity	IEC 60093	1 <sup>13</sup> / 1 <sup>7</sup>	Ω*m
Comparative Tracking Index	IEC 60112	400	V
Relative permittivity (100Hz)	IEC60250	3.9 / 22	-
Relative permittivity (1MHz)	IEC60250	3.6 / 4.5	-

NOTE:  
 DNB = Did not break  
 dry = Dry as moulded  
 cond = Conditioned  
 168hrs @ 23°C,  
 50 % RH  
 All tests undertaken at  
 23°C where applicab.  
 Information source see  
 page 77\*.

**Chemical resistance**  
 Chemical resistance:  
 PA46 Harnessflex TempGuard fittings are resistant to all under bonnet oils, greases, fuels, cleaning fluids and synthetic fluids. Like all Nylons they are resistant to weak acids but not resistant to strong or oxidizing acids.

**Product Temperature Range @1.5mm material thickness:**  
 Minimum -40°C  
 Maximum Permanent 30,000+ hours +160°C  
 Maximum short term 3,000 hours +200°C  
 Mechanical Protection High  
 UV Resistance High  
 Abrasion resistance High  
 Low smoke toxicity and halogen free  
 Self-Extinguishing

## Technical section

### Co-Polyester-ester

Co-Polyester-ester – Flame Retardant (halogen free), heat and UV stabilised. Used on: Harnessflex HTC conduits.

Properties	Test method	Value	Unit
<b>General</b>			
Density	ISO 1183	1320	kg/m <sup>3</sup>
Melting Point	ISO 11357	208	°C
<b>Mechanical</b>			
<b>Dry/cond</b>			
Stress at break	ISO 527-1/-2	20.5	MPa
Nominal Strain at break	ISO 527-1/-2	250	%
Tensile Modulus	ISO 527-1/-2	540	MPa
Izod notched impact strength (+23°C)	ISO 179/1eU	11	kJ/m <sup>2</sup>
Izod notched impact strength (-30°C)	ISO 179/1eU	3.2	kJ/m <sup>2</sup>
Charpy notched impact strength (+23°C)	ISO 179/1eA	11	kJ/m <sup>2</sup>
Charpy notched impact strength (-30°C)	ISO 179/1eA	3	kJ/m <sup>2</sup>
<b>Flammability</b>			
Flammability (@1.5mm)	FMVSS302	0	mm/min
Flammability (@0.75mm)	IEC60695-11-10	V-2	N/A
<b>Electrical</b>			
Dielectric strength	IEC 60243-1	18.7	kV/mm
Volume Resistivity	IEC 60093	>1E <sup>13</sup>	Ω*m
Comparative Tracking Index	IEC 60112	600	V
Relative permittivity (100Hz)	IEC60250	4.2	-
Relative permittivity (1MHz)	IEC60250	3.7	-
Dissipation factor (100Hz)	IEC60250	157	E-4
Dissipation factor (1MHz)	IEC60250	385	E-4

**NOTE:**

All tests undertaken at 23°C where applicable

\*Information Source - Polymer supplier published information.

#### Chemical resistance

Co-Polyester Harnessflex conduits are resistant to under bonnet oils, greases, fuels, cleaning fluids and acids. They are not resistant to transformer oils or brake fluids (DOT 3/4)

#### Product Temperature Range @1.5mm material thickness:

Minimum Static 30,000 hours -50°C

Minimum dynamic 5000 operations -45°C

Maximum static long term 30,000 hours +175°C

Maximum short term 3,000 hours +190°C

## Technical section

### Polyamide 12 (Nylon)

**Polyamide 12 (Nylon) – Plasticized, impact modified, heat and UV stabilised. Used on: All Harnessflex unreinforced nylon fittings.**

Properties	Test method	Value	Unit
<b>General</b>			
Density	ISO 1183	1.030	kg/m <sup>3</sup>
Melting Point	ISO 11357	173	°C
<b>Mechanical</b>			
<b>Dry/cond</b>			
Yield Stress	ISO 527-1/-2	25	MPa
Yield Strain	ISO 527-1/-2	20	%
Charpy impact strength (+23°C)	ISO 527-1/-2	400	MPa
Charpy impact strength (-30°C)	ISO 179/1eU	DNB	kJ/m <sup>2</sup>
Charpy notched impact strength (+23°C)	ISO 179/1eU	DNB	kJ/m <sup>2</sup>
Charpy notched impact strength (-30°C)	ISO 179/1eA	DNB	kJ/m <sup>2</sup>
<b>Thermal</b>			
Temp of deflection under load (1.80 Mpa)	ISO 75-1/-2	45	°C
Temp of deflection under load (0.45 Mpa)	ISO 75-1/-2	95	°C
<b>Flammability</b>			
Flammability (@0.8mm)	IEC60695-11-10	HB	N/A
<b>Electrical</b>			
Dielectric strength	IEC 60243-1	32	kV/mm
Surface Resistivity	IEC 60093	1E11	Ω
Volume Resistivity	IEC 60093	1E11	Ω*m
Comparative Tracking Index	IEC 60112	600	V

**NOTE:**

DNB = Did not break

dry = Dry as moulded

cond = Conditioned 168hrs @ 23°C, 50 % RH

All tests undertaken at 23°C where applicable

\*Information Source - Polymer supplier published information.

The data given is typical data and does not represent minimum values. Variations within normal tolerances are possible for different colours

#### Chemical resistance

PA12 Harnessflex conduits are resistant to all under bonnet oils, greases, fuels, cleaning fluids and synthetic fluids. Like all Nylons they are resistant to weak /medium acids but not resistant to strong or oxidizing acids.

#### Product Temperature Range @1.5mm material thickness:

Minimum Static 30,000 hours -50°C

Minimum dynamic 5000 operations -45°C

Maximum static long term 30,000 hours +105°C

Maximum short term 3,000 hours +120°C

## Technical section

### Thermoplastic elastometer TPV



SRN



SWM



SEG



ESN



EK

#### Thermoplastic Elastometer TPV - Material data sheet

Properties	Test method	Value	Unit
<b>General</b>			
Density	ISO 1183	0.96	g/cm <sup>3</sup>
Hardness shore A (5 sec)	ISO 868	56	–
Brittleness temperature	ISO 812	-62	°C
Flammability	UL94	HB	–
Stress/strain properties	ISO 37 (II)	–	–
<b>Flow Direction</b>			
Tensile strength	–	3.8	MPa
Modulus 100%	–	2.7	MPa
Elongation at break cross direction	–	280	%
Tensile strength	–	5.1	MPa
Modulus 100%	–	1.9	MPa
Elongation at break	–	470	%
<b>Tear Strength (cross direction)</b>			
Trouser	ISO 34 A	7	kN/m
Un-nicked angle	ISO 34 B (a)	22	kN/m
Compression set	ISO 815	–	–
72h/23°C	–	22	%
72h/70°C	–	26	%
72h/100°C	–	34	%
<b>Hot Air Ageing</b>			
1000h/125°C - Change in hardness	–	2	pts
Retention tensile strength	–	90	%
Retention - elongation at break	–	96	%
336h/150°C - Change in hardness	–	0	pts
Retention tensile strength	–	90	%
Retention elongation at break	–	87	%
<b>Volume Swell</b>			
72h/100°C water	–	+3	%
168h/100°C ASTM oil 1	–	+43	%
168h/100°C ref fuel B	–	+91	%

Used on: Sealing products.

A polypropylene based elastomer designed primarily for demanding automotive applications.

This material exhibits excellent compression set, flex fatigue and high and low temperature performance.

NOTE: Tests are conducted on injection moulded plaques. All tests undertaken at 23°C where applicable.

#### Chemical resistance

TPV fittings are resistant to: Water, acids, ethanol, glycerol, methanol and propanol, hydraulic brake fluid and antifreeze. Large volume swell (>60%) is experienced with certain oils and fuels.

#### Approvals

Individual parts are approved to different standards including NFR 13-903. Others are manufacturer specific or are new developments and may not be approved to certain standards. Please contact the technical office for specific enquiries.





---

**ABB UK Ltd**

CMG House

Station Road

Coleshill

Birmingham B46 1HT

Tel: +44 (0) 1675 468 217

Fax: +44 (0) 1675 468 280

E-Mail: [sales@harnessflex.co.uk](mailto:sales@harnessflex.co.uk)

**[www.harnessflex.com](http://www.harnessflex.com)**